

QCD at the LHC

KEN SASAKI*

*Dept. of Physics, Faculty of Engineering
Yokohama National University
Yokohama 240, JAPAN*

XX Vietnam School of Physics
Quy Nhon, August 3-15, 2014

Contents

1. Introduction
 2. Review on QED
 3. Quantum Chromodynamics (QCD)
 4. Asymptotic Freedom
 5. Deep Inelastic Scattering (DIS)
 6. Application of Perturbative QCD to DIS
 7. LHC
- (Appendix)
- A. Notations and Conventions
 - B. Scalar One-loop Integrals
 - C. Formulae for SU(3)
 - D. Renormalization Group Equation (RGE)
 - E. DIS from a Coordinate Space Viewpoint
 - F. QCD Analysis of Structure Functions – OPE and RGE method

*e-mail address: sasaki@ynu.ac.jp

(References)

T. Muta: Foundations of Quantum Chromodynamics (World Scientific)

Peskin and Schroeder: An Introduction to Quantum Field Theory (Addson-Wesley)

Cheng and Li: Gauge Theory of Elementary Particle Physics (Clarendon Press)

1 Introduction

1.1 Fundamental interactions in Nature

- Strong interaction: mediated by gluons
- Electromagnetic interaction: mediated by photons
- Weak interaction: mediated by weak (W^- and Z^-) bosons
- Gravity

1.2 Standard model of elementary particles

1.2.1 Basic ingredients

♣ Quarks (and anti-quarks)

- Hadrons – – – Particles with strong interactions
 Baryons (fermions) –– proton, nucleon,
- Mesons (bosons) –– pions, ρ mesons,
- Hadrons are made up of more fundamental particles called quarks
 (Gell-Mann and Zweig, 1964)
- Six different kinds of quarks have been discovered
 (Quarks have six different flavor quantum numbers)

| Quarks | electric charge |
|--|-----------------|
| up(u), charm(c), top(t) | $(2/3) e$ |
| down(d), strange(s), bottom(b) | $(-1/3) e$ |

♣ Leptons – – – Particles without strong interactions

| Leptons | electric charge |
|--|-----------------|
| e -neutrino(ν_e), μ -neutrino(ν_μ), τ -neutrino(ν_τ) | 0 |
| electron(e), muon(μ), tau(τ) | - e |

♣ Gauge bosons— Particles which mediate electromagnetic and weak interactionsphoton, W -boson, Z -boson

♣ Higgs boson

1.2.2 Gauge theories

- Fundamental interactions in Nature are described by gauge theories.

| Interaction | gauge bosons | gauge group |
|-----------------------------|------------------------|-------------|
| Strong Interaction | color gluon | $SU(3)$ |
| Electromagnetic Interaction | photon | $U(1)$ |
| Weak Interaction | W -boson, Z -boson | $SU(2)$ |
| Gravity | graviton | |

- The Standard Model of elementary particles is described by the gauge group

$$SU(3)_C \times SU(2)_L \times U(1)$$

- A short history of gauge theories
 - Local symmetries or gauge symmetries (Weyl 1929)
Abelian $U(1)$ gauge theory — QED
 - Non-Abelian gauge theories (Yang and Mills 1954)
 - Quantization of non-Abelian gauge theories (Faddeev and Popov 1967)
 - Discovery of Bjorken scaling in DIS (Friedman, Kendall and Taylor 1968)
 - Renormalizability of non-Abelian gauge theories ('t Hooft 1971)
 - Asymptotic freedom (Politzer, Gross and Wilczek, 't Hooft 1973)

2 Review on QED

2.1 Classical Electrodynamics

- ♣ Maxwell's equations in the vacuum with charge distribution ρ and current \mathbf{j} in the Heaviside-Lorentz system with "natural" units $c = \hbar = 1$

$$\nabla \cdot \mathbf{E} = \rho \quad \text{Gauss's law} \quad (1)$$

$$\nabla \cdot \mathbf{B} = 0 \quad \text{no magnetic monopole} \quad (2)$$

$$\nabla \times \mathbf{E} = -\frac{\partial \mathbf{B}}{\partial t} \quad \text{Faraday's law} \quad (3)$$

$$\nabla \times \mathbf{B} = \mathbf{j} + \frac{\partial \mathbf{E}}{\partial t} \quad (4)$$

- ◇ Introduction of 4-vector potential: $A^\mu = (\phi, \mathbf{A})$

$$(2) \implies \mathbf{B} = \nabla \times \mathbf{A} \quad (5)$$

$$(3) \implies \mathbf{E} = -\nabla\phi - \frac{\partial \mathbf{A}}{\partial t} \quad (6)$$

- The choice of 4-vector potential which represents \mathbf{E} and \mathbf{B} is not unique.
- A new 4-vector potential, which is obtained by the following transformation (gauge transformation), gives the same \mathbf{E} and \mathbf{B} :

$$\phi \longrightarrow \phi + \frac{\partial \Lambda}{\partial t}, \quad \mathbf{A} \longrightarrow \mathbf{A} - \nabla \Lambda \quad (7)$$

$$\text{equivalently } A^\mu \longrightarrow A^\mu + \partial^\mu \Lambda \quad (8)$$

- Maxwell's equations are invariant under the gauge transformation

- ♡ In classical electrodynamics

- Only \mathbf{E} and \mathbf{B} are physical quantities
- The 4-vector potential was introduced for convenience' sake
- Thus the gauge-invariance of the Maxwell's equations does not have a particular physical meaning

- ♠ In terms of the field strength $F^{\mu\nu}$

$$F^{\mu\nu} \equiv \partial^\mu A^\nu - \partial^\nu A^\mu = \begin{pmatrix} 0 & -E_x & -E_y & -E_z \\ E_x & 0 & -B_z & B_y \\ E_y & B_z & 0 & -B_x \\ E_z & -B_y & B_x & 0 \end{pmatrix} \quad (9)$$

the Maxwell's equations, Eqs.(1)-(4), are rewritten in covariant form as

$$\partial_\mu F^{\mu\nu} = j^\nu \quad (10)$$

where j^μ is the 4-vector electric current

$$j^\mu = (\rho, \mathbf{j}) \quad (11)$$

- The field strength $F_{\mu\nu}$ is invariant under the gauge transformation given in Eq.(8).

2.2 Quantum Electrodynamics

♡ In quantum electrodynamics

- Introduction of the 4-vector potential is necessary (the theory cannot be constructed only with \mathbf{E} and \mathbf{B})
- Aharonov-Bohm effect: the quantum-mechanical interference of the charged particles in a region with $\mathbf{B} = \mathbf{0}$ but $\mathbf{A} \neq \mathbf{0}$.

The AB effect was predicted in 1959 and observed in 1986.

- The gauge-invariance is the consequence of the gauge symmetry satisfied by the quantum electrodynamics \Leftarrow Gauge principle

♣ Gauge principle

C. N. Yang

"Now if we adopt the view that this arbitrary convention should be independently chosen at every space-time point, then we are naturally led to the concept of gauge fields."

(1) Charge conservation

Suppose scalar particles a, b, c, d have electric charges Q_a, Q_b, Q_c, Q_d (in units of e) and are represented by the fields $\phi_a, \phi_b, \phi_c, \phi_d$.

* Imagine a reaction

$$a + b \longrightarrow c + d \quad (12)$$

occurs at a space-time point. Then its interaction is expressed as

$$S_{\text{int}} = \int d^4x \phi_c^* \cdot \phi_d^* \cdot \phi_a \cdot \phi_b \quad (13)$$

* (Electric) charge conservation requires

$$Q_a + Q_b = Q_c + Q_d \quad (14)$$

↓

* S_{int} in Eq.(13) is invariant under a $U(1)$ global gauge transformation

$$\phi_i \longrightarrow e^{-iQ_i\theta} \phi_i, \quad i = a, b, c, d, \quad (15)$$

$$S_{\text{int}} \longrightarrow \int d^4x \exp [i\theta(Q_c + Q_d - Q_a - Q_b)] \phi_c^* \cdot \phi_d^* \cdot \phi_a \cdot \phi_b = S_{\text{int}} \quad (16)$$

♡ Conservation laws \iff Symmetries (invariance under transformations)

(2) Local gauge transformation

Suppose the gauge parameter θ depends on the space-time:

$$\phi_i \longrightarrow e^{-iQ_i\theta(x)} \phi_i, \quad (17)$$

◇ [Gauge principle]

Impose that theories should be invariant under local gauge transformations

↓

* To maintain the gauge invariance, we need an introduction of gauge bosons (massless spin-one vector mesons), because the kinetic term of the charged scalar field ϕ_i is written as $|\partial_\mu \phi_i|^2$ and

$$\begin{aligned} \partial_\mu \phi_i &\longrightarrow \partial_\mu (e^{-iQ_i\theta(x)} \phi_i) \\ &= e^{-iQ_i\theta(x)} \partial_\mu \phi_i - iQ_i \partial_\mu \theta(x) e^{-iQ_i\theta(x)} \phi_i \\ &\neq e^{-iQ_i\theta(x)} \partial_\mu \phi_i \end{aligned} \quad (18)$$

* Introduce a gauge field A_μ which transforms under local gauge transformation [see Eq.(8)]:

$$A_\mu \longrightarrow A_\mu - \frac{1}{e} \partial_\mu \theta(x) \quad (19)$$

Then the minimal coupling of a charged particle to a gauge field transforms as

$$\begin{aligned} (\partial_\mu - ieQ_i A_\mu) \phi_i &\longrightarrow (\partial_\mu - ieQ_i [A_\mu - \frac{1}{e} \partial_\mu \theta(x)]) e^{-iQ_i\theta(x)} \phi_i \\ &= e^{-iQ_i\theta(x)} (\partial_\mu - ieQ_i A_\mu) \phi_i \end{aligned} \quad (20)$$

Thus the gauge invariance is maintained

♡ Gauge principle leads to

- * introduction of gauge bosons into theories
- * fixing the interaction forms of matter fields to gauge bosons (minimal coupling)

♣ Classical Lagrangian for electrodynamics of a Dirac particle:

$$\mathcal{L}_{EM} = -\frac{1}{4}F_{\mu\nu}F^{\mu\nu} + \bar{\psi}(i\gamma^\mu D_\mu - m)\psi \quad (21)$$

where $F_{\mu\nu} = \partial_\mu A_\nu - \partial_\nu A_\mu$, ψ is a Dirac field with mass m and electric charge eQ and D_μ is called the covariant derivative and defined as

$$D_\mu = \partial_\mu - ieQA_\mu \quad (22)$$

- \mathcal{L}_{EM} is invariant under the following local gauge transformation

$$\begin{aligned} \psi &\rightarrow \psi' = e^{-iQ\theta(x)}\psi \\ A_\mu &\rightarrow A'_\mu = A_\mu - \frac{1}{e}\partial_\mu\theta(x) \end{aligned} \quad (23)$$

In fact, we find under the above transformation

$$F_{\mu\nu} \rightarrow F_{\mu\nu}, \quad \bar{\psi} \rightarrow \bar{\psi}e^{iQ\theta(x)}, \quad D_\mu\psi \rightarrow e^{-iQ\theta(x)}D_\mu\psi \quad (24)$$

2.3 Quantization

- A simple-minded application of canonical quantization gives

$$A_\mu \longrightarrow \pi_\mu = \frac{\partial\mathcal{L}_{EM}}{\partial\dot{A}^\mu} = -F_{0\mu} \implies \pi_0 = 0,$$

and so we cannot define a equal-time commutator for $[A_0, \pi_0] = ?$.

- We add to \mathcal{L}_{EM} a gauge fixing term

$$\mathcal{L}_{GF} = -\frac{1}{2\xi}(G)^2 \quad (25)$$

where

$$\begin{aligned} G = 0 & \quad \text{Gauge fixing conditions} \\ \xi : & \quad \text{Gauge parameter} \end{aligned}$$

Examples:

$$\begin{aligned} \partial^\mu A_\mu = 0 & \quad \text{Covariant gauge (Lorentz gauge)} \\ \partial_i A_i = 0 & \quad \text{Coulomb gauge} \\ n^\mu A_\mu = 0 & \quad \text{Temporal axial gauge} \quad n^\mu = (1, 0, 0, 0) \end{aligned} \quad (26)$$

♣ QED Lagrangian

$$\mathcal{L}_{QED} = \mathcal{L}_{EM} + \mathcal{L}_{EM,GF} \quad (27)$$

- \mathcal{L}_{QED} is not invariant anymore under the gauge transformation (23).
- Green functions (off-shell quantities) calculated from \mathcal{L}_{QED} depend on which gauge-fixing-condition we have chosen and on the gauge-parameter.
- But S -matrix and other physical quantities predicted by the Lagrangian \mathcal{L}_{QED} are gauge-invariant and also gauge-independent (i.e., independent of the gauge parameter ξ)

From now on we only deal with the covariant gauge (Lorentz gauge).

2.4 Feynman rules in QED

- ♠ We divide \mathcal{L}_{QED} in (27) into the free part ($\mathcal{L}_0^{\text{Photon}} + \mathcal{L}_0^F$) and the interaction part \mathcal{L}_I :

$$\mathcal{L}_{QED} = \mathcal{L}_0^{\text{Photon}} + \mathcal{L}_0^F + \mathcal{L}_I \quad (28)$$

where

$$\mathcal{L}_0^{\text{Photon}} = -\frac{1}{4}F_{\mu\nu}F^{\mu\nu} - \frac{1}{2\xi}(\partial^\mu A_\mu)^2 \quad (29)$$

$$\mathcal{L}_0^F = \bar{\psi}(i\gamma^\mu\partial_\mu - m)\psi \quad (30)$$

$$\mathcal{L}_I = eQ\bar{\psi}\gamma^\mu\psi A_\mu \quad (31)$$

- photon propagator:

The action for the free electromagnetic field is written (after integration by parts) as

$$\int d^4x \mathcal{L}_0^{\text{Photon}}(x) = \frac{1}{2} \int d^4x A_\mu(x)(\partial^2 g^{\mu\nu} - \partial^\mu\partial^\nu + \frac{1}{\xi}\partial^\mu\partial^\nu)A_\nu(x) \quad (32)$$

The photon propagator in the covariant gauge is given by the solution for

$$(\partial^2 g^{\mu\nu} - \partial^\mu\partial^\nu + \frac{1}{\xi}\partial^\mu\partial^\nu)D_{\text{photon}}^{\nu\rho}(x-y) = i\delta_\mu^\rho\delta^4(x-y) \quad (33)$$

which is

$$D_{\text{photon}}^{\mu\nu}(x-y) = \int \frac{d^4k}{(2\pi)^4} \frac{-i}{k^2 + i\epsilon} \left[g^{\mu\nu} - (1-\xi)\frac{k^\mu k^\nu}{k^2} \right] e^{-ik\cdot(x-y)} \quad (34)$$

- Fermion (or electron) propagator:
Solving the equation

$$(i\gamma^\mu \partial_\mu - m)S_F(x - y) = i\delta^4(x - y) \quad (35)$$

we obtain for the Fermion propagator

$$S_F(x - y) = \int \frac{d^4p}{(2\pi)^4} \frac{i}{\not{p} - m + i\epsilon} e^{-ip \cdot (x-y)} \quad (36)$$

- The charged-fermion-photon coupling:
Since

$$\int d^4x i\mathcal{L}_I(x) = \int d^4x \bar{\psi}(x) [ieQ\gamma^\mu] \psi(x) A_\mu(x), \quad (37)$$

we obtain for the Feynman rule of the fermion-photon coupling

$$ieQ\gamma^\mu \quad (38)$$

◇ Summary of the Feynman rules in momentum space in QED

- Photon propagator: $\widetilde{D}_{\text{photon}}^{\mu\nu}(k) = \frac{-i}{k^2 + i\epsilon} [g^{\mu\nu} - (1 - \xi) \frac{k^\mu k^\nu}{k^2}]$
 - * Feynman gauge: $\xi = 1$
 - * Landau gauge: $\xi = 0$
- Fermion propagator: $\widetilde{S}_F(p) = \frac{i}{\not{p} - m + i\epsilon}$
- Fermion-photon coupling: $ieQ\gamma^\mu$

◇ A few examples of Feynman diagrams in QED

- electron-electron scattering
- Compton scattering
- photon self-energy

2.5 Renormalization of QED

Ref. Peskin and Schroeder, Chap.10

◇ QED is a renormalizable perturbation theory:

Ultraviolet divergences appear only in a finite number of amplitudes and these divergences can be absorbed into unobservable Lagrangian parameters.

- The original QED Lagrangian with bare fields ψ_{bare} and A_{bare}^μ , bare mass m_0 and bare electric charge e_0 is

$$\mathcal{L} = -\frac{1}{4}(F_{\text{bare}}^{\mu\nu})^2 + \bar{\psi}_{\text{bare}}(i\cancel{\partial} - m_0)\psi_{\text{bare}} + e_0 Q \bar{\psi}_{\text{bare}} \gamma_\mu \psi_{\text{bare}} A_{\text{bare}}^\mu \quad (39)$$

- Rescale the bare fields with the renormalized fields ψ and A^μ as

$$\psi_{\text{bare}} = Z_2^{1/2} \psi, \quad A_{\text{bare}}^\mu = Z_3^{1/2} A^\mu \quad (40)$$

together with

$$Z_2 m_0 = m + \delta m, \quad e_0 Z_2 Z_3^{1/2} = e Z_1 \quad (41)$$

where m is the physical mass (the pole mass of the fermion propagator) and e is the physical electric charge measured at large distances ($q = 0$). Then \mathcal{L} is rewritten as

$$\begin{aligned} \mathcal{L} &= -\frac{1}{4} Z_3 (F^{\mu\nu})^2 + Z_2 \bar{\psi} (i\gamma^\mu \cancel{\partial} - m_0) \psi + e_0 Q Z_2 Z_3^{1/2} \bar{\psi} \gamma_\mu \psi A^\mu \\ &= -\frac{1}{4} (F^{\mu\nu})^2 + \bar{\psi} (i\cancel{\partial} - m) \psi + e Q \bar{\psi} \gamma_\mu \psi A^\mu \\ &\quad - \frac{1}{4} (Z_3 - 1) (F^{\mu\nu})^2 + \bar{\psi} (i[Z_2 - 1]\cancel{\partial} - \delta m) \psi + e Q (Z_1 - 1) \bar{\psi} \gamma_\mu \psi A^\mu \end{aligned} \quad (42)$$

- The terms in the second line of Eq.(42) act as counterterms.

In momentum space, they are expressed as

$$\begin{aligned} i(Z_3 - 1) \frac{1}{2} A_\mu(x) (\partial^2 g^{\mu\nu} - \partial^\mu \partial^\nu) A_\nu(x) &\implies -i(Z_3 - 1) (g^{\mu\nu} q^2 - q^\mu q^\nu) \\ i\bar{\psi} (i[Z_2 - 1]\cancel{\partial} - \delta m) \psi &\implies i((Z_2 - 1)\cancel{\not{p}} - \delta m) \\ ieQ(Z_1 - 1) \bar{\psi} \gamma_\mu \psi A^\mu &\implies ieQ(Z_1 - 1) \gamma^\mu \end{aligned} \quad (43)$$

- Renormalization constants Z_1 , Z_2 and Z_3 and mass shift δm are expanded in powers of $\alpha = e^2/(4\pi)$ as

$$Z_i = 1 + Z_i^{(1)}(\alpha) + Z_i^{(2)}(\alpha^2) + \dots, \quad i = 1, 2, 3 \quad (44)$$

$$\delta m = m \left(\delta_m^{(1)}(\alpha) + \delta_m^{(2)}(\alpha^2) + \dots \right) \quad (45)$$

- The renormalization conditions are specified to define the physical mass and physical electric charge and to keep the residues of the fermion and photon propagators equal to 1.
- Adjust the counterterms coefficients $Z_i^{(1)}, Z_i^{(2)}, \dots$ ($i = 1, 2, 3$) and $\delta_m^{(1)}, \delta_m^{(2)}, \dots$ to maintain the renormalization conditions.

◇ Renormalization conditions of QED: (on-shell renormalization scheme)

1. Fix the fermion mass at m : $\Sigma(\not{p} = m) = 0$,
where $-i\Sigma(\not{p})$ is the sum of the *one-particle irreducible* (1PI) fermion self-energy diagrams expressed in Fig.9(b) (including the contribution of the counterterm)
2. Fix the residue of the fermion propagator at 1: $\left. \frac{d}{d\not{p}} \Sigma(\not{p}) \right|_{\not{p}=m} = 0$,
3. Fix the residue of the photon propagator at 1: $\Pi(q^2 = 0) = 0$,
where $i\Pi^{\mu\nu}(q) = i(g^{\mu\nu}q^2 - q^\mu q^\nu)\Pi(q^2)$ is the sum of the 1PI photon self-energy diagrams expressed in Fig.9(a) (including the contribution of the counterterm).
4. Fix the electric charge to be e under the above conditions:
 $\Gamma^\mu(p' - p = 0) = \gamma^\mu$
where $ieQ\Gamma^\mu(p', p)$ is the fermion-photon vertex function shown in Fig.9(c) (including the contribution of the counterterm).

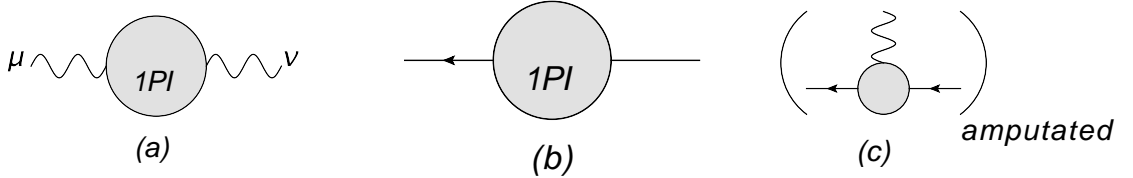

Figure 1: (a) Photon self-energy, $i\Pi^{\mu\nu}(q)$; (b) Fermion self-energy, $-i\Sigma(\not{p})$; (c) Vertex correction, $-ie\Gamma^\mu(p', p)$.

2.5.1 Regularization

Ultraviolet divergences appear from loop-integrals of the photon self-energy diagrams $\Pi^{\mu\nu}(q)$, fermion self-energy diagrams $\Sigma(\not{p})$ and fermion-photon vertex function $\Gamma^\mu(p', p)$.

- We first regulate these divergences and then, using the renormalization conditions, cancel them by the counterterms. And we obtain finite expressions for measurable quantities.

- Most often used now and most suitable for gauge theories is dimensional regularization, which preserves Lorentz invariance, gauge invariance and unitarity, etc.

◇ [Dimensional regularization]

- Calculate Feynman diagrams with space-time dimension $4 \rightarrow n$

$$\int \frac{d^4 k}{(2\pi)^4} \Rightarrow \int \frac{d^n k}{(2\pi)^n}, \quad e \Rightarrow e\mu^\epsilon \quad (\text{with } \epsilon = \frac{4-n}{2}) \quad (46)$$

- Results are finite.

- Divergences show up as poles $\frac{2}{4-n} = \frac{1}{\epsilon}$, when the dimension $n \rightarrow 4$.

2.6 One-loop calculation of $Z_1^{(1)}$, $Z_2^{(1)}$, $Z_3^{(1)}$ and $\delta_m^{(1)}$

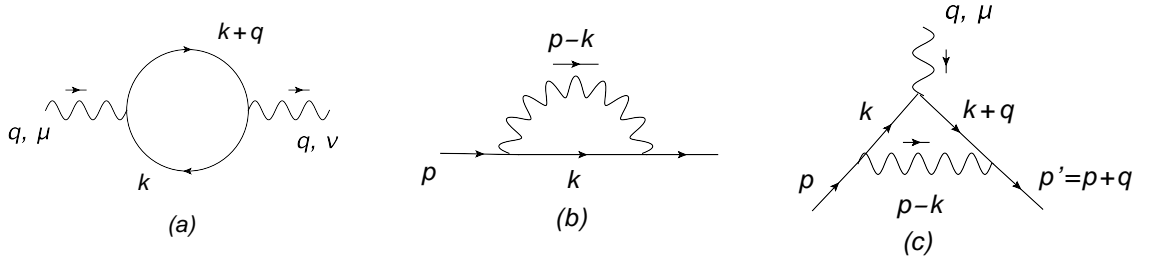

Figure 2: One-loop diagrams: (a) Photon self-energy, $\Pi_{(1)}^{\mu\nu}(q)$; (b) Electron self-energy, $\Sigma_{(1)}(\not{p})$; (c) Vertex correction, $\Gamma_{(1)}^\mu(p', p)$.

2.6.1 Photon Self-energy

The contribution to the photon self-energy $i\Pi^{\mu\nu}(q)$ in leading order of α is written as (see Fig.2(a))

$$\begin{aligned} i\Pi_{(1)}^{\mu\nu}(q) &= (-ie\mu^\epsilon)^2(-1) \int \frac{d^n k}{(2\pi)^n} \text{Tr} \left[\gamma^\mu \frac{i}{\not{k} - m} \gamma^\nu \frac{i}{\not{k} + \not{q} - m} \right] \\ &= -(e\mu^\epsilon)^2 \int \frac{d^n k}{(2\pi)^n} \frac{\text{Tr}[\gamma^\mu(\not{k} + m)\gamma^\nu(\not{k} + \not{q} + m)]}{(k^2 - m^2)((k+q)^2 - m^2)} \end{aligned} \quad (47)$$

$$\begin{aligned} N^{\mu\nu} &\equiv \text{Tr}[\gamma^\mu(\not{k} + m)\gamma^\nu(\not{k} + \not{q} + m)] \\ &= 4\{g^{\mu\nu}(-k \cdot q + m^2 - k^2) + 2k^\mu k^\nu + q^\mu k^\nu + k^\mu q^\nu\} \end{aligned} \quad (48)$$

$$\frac{1}{[k^2 - m^2][(k+q)^2 - m^2]} = \int_0^1 dx_1 dx_2 \delta(x_1 + x_2 - 1) \frac{\Gamma(2)}{\{[k^2 - m^2]x_1 + [(k+q)^2 - m^2]x_2\}^2}$$

$$\begin{aligned}
&= \int_0^1 dx_1 dx_2 \delta(x_1 + x_2 - 1) \frac{\Gamma(2)}{\{(k + qx_2)^2 + q^2 x_2 - m^2 - q^2 x_2^2\}^2} \\
&= \int_0^1 dx_2 \frac{1}{[l^2 - \mathcal{D}]^2}
\end{aligned} \tag{49}$$

where

$$\begin{aligned}
l &= k + qx_2 \\
\mathcal{D} &\equiv -q^2 x_2 + m^2 + q^2 x_2^2 = m^2 - q^2 x_2(1 - x_2)
\end{aligned}$$

We obtain $(n = 4 - 2\epsilon)$

$$\Pi_{(1)}^{\mu\nu}(q) = i(e\mu^\epsilon)^2 \int_0^1 dx_2 \int \frac{d^n l}{(2\pi)^n} \frac{N^{\mu\nu}}{[l^2 - \mathcal{D}]^2} \tag{50}$$

- The change of the integration variable from k to l , so that $k = l - qx_2$:
Discarding linear terms in l , we obtain

$$\begin{aligned}
N^{\mu\nu} &\implies 4\{g^{\mu\nu}(q^2 x_2 - (l^2 + q^2 x_2^2) + m^2) + 2(l^\mu l^\nu + q^\mu q^\nu x_2^2) - 2q^\mu q^\nu x_2\} \\
&= 4g^{\mu\nu} l^2 \left(-1 + \frac{2}{n}\right) + 4g^{\mu\nu} [m^2 + q^2 x_2(1 - x_2)] - 8q^\mu q^\nu x_2(1 - x_2)
\end{aligned} \tag{51}$$

where we have used the fact $l_\mu l_\nu = \frac{1}{n} l^2 g_{\mu\nu}$.

- Using the formulae,

$$\int \frac{d^n l}{(2\pi)^n} \frac{l^2}{[l^2 - \mathcal{D}]^2} = \frac{-i}{16\pi^2} (4\pi)^\epsilon \frac{n}{2} \frac{\Gamma(-1 + \epsilon)}{[\mathcal{D}]^{-1 + \epsilon}} \tag{52}$$

$$\int \frac{d^n l}{(2\pi)^n} \frac{1}{[l^2 - \mathcal{D}]^2} = \frac{i}{16\pi^2} (4\pi)^\epsilon \frac{\Gamma(\epsilon)}{[\mathcal{D}]^\epsilon} \tag{53}$$

$$\left(-1 + \frac{2}{n}\right) \frac{n}{2} \Gamma(-1 + \epsilon) = (-1 + \epsilon) \Gamma(-1 + \epsilon) = \Gamma(\epsilon) \tag{54}$$

we find

$$\begin{aligned}
\Pi_{(1)}^{\mu\nu}(q) &= i(e\mu^\epsilon)^2 \int_0^1 dx_2 \frac{i}{16\pi^2} (4\pi)^\epsilon \frac{\Gamma(\epsilon)}{[\mathcal{D}]^\epsilon} \\
&\quad \times \left[-4g^{\mu\nu} \mathcal{D} + 4g^{\mu\nu} [m^2 + q^2 x_2(1 - x_2)] - 8q^\mu q^\nu x_2(1 - x_2)\right] \\
&= -\frac{e^2}{16\pi^2} (4\pi\mu^2)^\epsilon (q^2 g^{\mu\nu} - q^\mu q^\nu) 8 \int_0^1 dx_2 x_2(1 - x_2) \frac{\Gamma(\epsilon)}{[\mathcal{D}]^\epsilon} \\
&\equiv (q^2 g^{\mu\nu} - q^\mu q^\nu) \Pi_{(1)}(q^2)
\end{aligned} \tag{55}$$

- Using the formulae

$$\Gamma(\epsilon) = e^{-\epsilon\gamma_E} \left(\frac{1}{\epsilon} + \mathcal{O}(\epsilon)\right) \tag{56}$$

$$\begin{aligned}
(\mathcal{D})^{-\epsilon} &= (m^2)^{-\epsilon} \left[1 - \frac{q^2}{m^2} x_2(1 - x_2)\right]^{-\epsilon} \\
&= (m^2)^{-\epsilon} \left\{1 - \epsilon \log\left[1 - \frac{q^2}{m^2} x_2(1 - x_2)\right] + \mathcal{O}(\epsilon^2)\right\}
\end{aligned} \tag{57}$$

where $\gamma_E = 0.57721 \dots$ is Euler constant, we obtain

$$\begin{aligned} \Pi_{(1)}(q^2) &= -\frac{e^2}{16\pi^2} \left(\frac{4\pi\mu^2}{m^2}\right)^\epsilon e^{-\epsilon\gamma_E} 8 \int_0^1 dx_2 x_2(1-x_2) \\ &\quad \times \left\{ \frac{1}{\epsilon} - \log\left[1 - \frac{q^2}{m^2} x_2(1-x_2)\right] + \mathcal{O}(\epsilon) \right\} \end{aligned} \quad (58)$$

- Finally we obtain

$$\Pi_{(1)}(0) = -\frac{\alpha}{4\pi} \left(\frac{4\pi\mu^2}{m^2}\right)^\epsilon e^{-\epsilon\gamma_E} \frac{4}{3} \frac{1}{\epsilon} \quad (59)$$

$$\Pi_{(1)}(q^2) - \Pi_{(1)}(0) = \frac{\alpha}{4\pi} 8 \int_0^1 dx_2 x_2(1-x_2) \log\left[1 - \frac{q^2}{m^2} x_2(1-x_2)\right] \quad (60)$$

[[Use of FeynCalc]]

FeynCalc is a *Mathematica* package for algebraic calculations in high energy physics (refer to feyncalc.org)

- With help of FeynCalc, especially using the code called “PaVeReduce[OneLoop[\dots]]”, the loop-integral in Eq.(47) is expressed in terms of the Passarino-Veltman one-point integral $A_0(m^2)$ and two-point integral $B_0(q^2; m^2, m^2)$ as follows:

$$\begin{aligned} (2\pi\mu)^{4-n} \int d^n k \frac{N^{\mu\nu}}{(k^2 - m^2)((k+q)^2 - m^2)} &= (g^{\mu\nu} q^2 - q^\mu q^\nu) \\ &\quad \times \frac{4i\pi^2}{3q^2} \left\{ (2m^2 + q^2) B_0(q^2; m^2, m^2) - 2A_0(m^2) + (2m^2 - \frac{q^2}{3}) \right\} \end{aligned} \quad (61)$$

- Thus we find

$$\begin{aligned} \Pi_{(1)}(q^2) &= \frac{ie^2}{(2\pi)^4} \frac{4i\pi^2}{3q^2} \left\{ 2m^2 \left[B_0(q^2; m^2, m^2) - \frac{1}{m^2} A_0(m^2) + 1 \right] \right. \\ &\quad \left. + q^2 \left[B_0(q^2; m^2, m^2) - \frac{1}{3} \right] \right\} \end{aligned} \quad (62)$$

Using the relation (327), $\Pi_{(1)}(q)$ is rewritten as

$$\begin{aligned} \Pi_{(1)}(q^2) &= -\frac{e^2}{16\pi^2} \frac{4}{3} \left\{ \frac{2m^2}{q^2} \left[B_0(q^2; m^2, m^2) - B_0(0; m^2, m^2) \right] \right. \\ &\quad \left. + \left[B_0(q^2, m^2, m^2) - \frac{1}{3} \right] \right\} \end{aligned} \quad (63)$$

- For $q^2 < 0$, we obtain

$$\begin{aligned} B_0(q^2; m^2, m^2) &= \left(\frac{4\pi\mu^2}{m^2}\right)^\epsilon e^{-\epsilon\gamma_E} \\ &\quad \times \left(\frac{1}{\epsilon} + 2 - \sqrt{\frac{4m^2}{-q^2} + 1} \log\left(\frac{\sqrt{4m^2 - q^2} + \sqrt{-q^2}}{\sqrt{4m^2 - q^2} - \sqrt{-q^2}}\right) + \mathcal{O}(\epsilon) \right) \end{aligned} \quad (64)$$

$$B_0(0; m^2, m^2) = \left(\frac{4\pi\mu^2}{m^2}\right)^\epsilon e^{-\epsilon\gamma_E} \left(\frac{1}{\epsilon} + \mathcal{O}(\epsilon)\right) \quad (65)$$

In the limit $q^2 \rightarrow 0$, we find

$$B_0(q^2; m^2, m^2) - B_0(0; m^2, m^2) \implies \frac{q^2}{6m^2}$$

Finally we obtain

$$\Pi_{(1)}(0) = -\frac{\alpha}{4\pi} \left(\frac{4\pi\mu^2}{m^2} \right)^\epsilon e^{-\epsilon\gamma_E} \frac{4}{3} \frac{1}{\epsilon} \quad (66)$$

$$\begin{aligned} \hat{\Pi}_{(1)}(q^2) &\equiv \Pi_{(1)}(q^2) - \Pi_{(1)}(0) \\ &= -\frac{\alpha}{4\pi} \frac{4}{3} \left\{ \left(\frac{2m^2}{q^2} + 1 \right) \left[2 - \sqrt{\frac{4m^2}{-q^2} + 1} \log \left(\frac{\sqrt{4m^2 - q^2} + \sqrt{-q^2}}{\sqrt{4m^2 - q^2} - \sqrt{-q^2}} \right) \right] - \frac{1}{3} \right\} \end{aligned} \quad (67)$$

For large $|-q^2| \gg m^2$, we find

$$\hat{\Pi}_{(1)}(q^2) \approx -\frac{\alpha}{4\pi} \frac{4}{3} \left\{ -\log \left(\frac{-q^2}{m^2} \right) + \frac{5}{3} \right\} \quad (68)$$

- Renormalization constant $Z_3^{(1)}(\alpha)$:

The renormalization condition requires $\Pi_{(1)}(q^2 = 0) - Z_3^{(1)}(\alpha) = 0$, which leads to (we set $\mu^2 = m^2$ and $S^\epsilon \equiv (4\pi)^\epsilon e^{-\epsilon\gamma_E}$)

$$Z_3^{(1)}(\alpha) = \Pi_{(1)}(0) = -\frac{\alpha}{4\pi} S^\epsilon \frac{1}{\epsilon} \frac{4}{3} \quad (69)$$

2.6.2 Fermion Self-energy

The contribution to the fermion self-energy $-i\Sigma(\not{p})$ in leading order of α is written as (see Fig.2(b))

$$\begin{aligned} -i\Sigma_{(1)}(\not{p}) &= (-ie\mu^\epsilon)^2 \int \frac{d^n k}{(2\pi)^n} \gamma^\mu \frac{i}{\not{k} - m} \gamma^\mu \frac{-i}{(p-k)^2 - \lambda^2} \\ &= -(e\mu^\epsilon)^2 \int \frac{d^n k}{(2\pi)^n} \frac{\gamma^\mu (\not{k} + m) \gamma_\mu}{(k^2 - m^2)((p-k)^2 - \lambda^2)} \end{aligned} \quad (70)$$

Since $\Sigma_{(1)}(\not{p})$ has an infrared divergence, we have introduced a small photon mass λ .

$$N \equiv \gamma^\mu (\not{k} + m) \gamma_\mu = (2-n)\not{k} + n m \quad (71)$$

- With help of FeynCalc, we obtain

$$\begin{aligned} (2\pi\mu)^{4-n} \int d^n k \frac{N}{(k^2 - m^2)((p-k)^2 - \lambda^2)} &= i\pi^2 \left\{ (4m - \not{p}) B_0(p^2; m^2, \lambda^2) \right. \\ &\quad \left. - \frac{(m^2 - \lambda^2)\not{p}}{p^2} [B_0(p^2; m^2, \lambda^2) - B_0(0; m^2, \lambda^2)] - 2m + \not{p} \right\} \end{aligned} \quad (72)$$

- Thus we find (setting $\lambda^2 = 0$ in the coefficients)

$$\begin{aligned}\Sigma_{(1)}(\not{p}) &= \frac{-ie^2}{(2\pi)^4} i\pi^2 \left\{ (4m - \not{p}) B_0(p^2; m^2, \lambda^2) \right. \\ &\quad \left. - \frac{m^2 \not{p}}{p^2} [B_0(p^2; m^2, \lambda^2) - B_0(0; m^2, \lambda^2)] - 2m + \not{p} \right\} \quad (73)\end{aligned}$$

- Two-point functions B_0 's do not have infrared divergences but their derivatives may have ones. Setting $\lambda^2 = 0$ in B_0 's, we find from the results in (333) and (335)

$$\begin{aligned}\Sigma_{(1)}(\not{p} = m) &= \frac{e^2}{16\pi^2} m \left\{ 2B_0(m^2; m^2, 0) + B_0(0; m^2, 0) - 1 \right\} \\ &= \frac{e^2}{16\pi^2} m \left(\frac{4\pi\mu^2}{m^2} \right)^\epsilon e^{-\epsilon\gamma_E} \left(\frac{3}{\epsilon} + 4 + \mathcal{O}(\epsilon) \right) \quad (74)\end{aligned}$$

- Since $\frac{d}{d\not{p}} B_0(p^2; m^2, \lambda^2) = 2\not{p} \frac{d}{dp^2} B_0(p^2; m^2, \lambda^2)$, and using the result $\frac{d}{dp^2} B_0(p^2; m^2, \lambda^2) \Big|_{p^2=m^2}$ given in (331), we find

$$\begin{aligned}\frac{d}{d\not{p}} \Sigma_{(1)}(\not{p}) \Big|_{\not{p}=m} &= \frac{e^2}{16\pi^2} \left\{ -B_0(m^2; m^2, \lambda^2) + 3m \cdot 2m \frac{d}{dp^2} B_0(p^2; m^2, \lambda^2) \Big|_{p^2=m^2} \right. \\ &\quad \left. + [B_0(m^2; m^2, \lambda^2) - B_0(0; m^2, \lambda^2)] - m \cdot 2m \frac{d}{dp^2} B_0(p^2; m^2, \lambda^2) \Big|_{p^2=m^2} + 1 \right\} \\ &\Rightarrow \frac{e^2}{16\pi^2} \left\{ -B_0(0; m^2, 0) + 4m^2 \frac{d}{dp^2} B_0(p^2; m^2, \lambda^2) \Big|_{p^2=m^2} + 1 \right\} \\ &= \frac{e^2}{16\pi^2} \left(\frac{4\pi\mu^2}{m^2} \right)^\epsilon e^{-\epsilon\gamma_E} \left(-\frac{1}{\epsilon} - 4 - 2 \log \frac{\lambda^2}{m^2} + \mathcal{O}(\epsilon) \right) \quad (75)\end{aligned}$$

- Renormalization constants $Z_2^{(1)}(\alpha)$ and $\delta_m^{(1)}(\alpha)$:

The renormalization condition requires

$$\begin{aligned}0 &= \Sigma_{(1)}(\not{p} = m) - (Z_2^{(1)}(\alpha)m - \delta_m^{(1)}(\alpha)m) \\ 0 &= \frac{d}{d\not{p}} \Sigma_{(1)}(\not{p}) \Big|_{\not{p}=m} - Z_2^{(1)}(\alpha)\end{aligned} \quad (76)$$

Then we obtain (setting $\mu^2 = m^2$)

$$\begin{aligned}Z_2^{(1)}(\alpha) &= \frac{\alpha}{4\pi} S^\epsilon \left(-\frac{1}{\epsilon} - 4 - 2 \log \frac{\lambda^2}{m^2} \right) \\ \delta_m^{(1)}(\alpha) &= Z_2^{(1)}(\alpha) - \frac{1}{m} \Sigma_{(1)}(\not{p} = m) = \frac{\alpha}{4\pi} S^\epsilon \left(-\frac{4}{\epsilon} - 8 - 2 \log \frac{\lambda^2}{m^2} \right)\end{aligned} \quad (77)$$

2.6.3 Fermion vertex function

The contribution to the fermion vertex function $\Gamma^\mu(p', p)$ in leading order of α is written as (see Fig.2(c))

$$\begin{aligned}\Gamma_{(1)}^\mu(p', p) &= (-ie\mu^\epsilon)^2 \int \frac{d^n k}{(2\pi)^n} \gamma^\nu \frac{i}{\not{k} + \not{q} - m} \gamma^\mu \frac{i}{\not{k} - m} \gamma_\nu \frac{-i}{(p-k)^2 - \lambda^2} \\ &= -i(e\mu^\epsilon)^2 \int \frac{d^n k}{(2\pi)^n} \frac{\gamma^\nu (\not{k} + \not{q} + m) \gamma^\mu (\not{k} + m) \gamma_\nu}{((k+q)^2 - m^2)(k^2 - m^2)((p-k)^2 - \lambda^2)}\end{aligned}\quad (78)$$

where $p' = p+q$ and note that $\Gamma_{(1)}^\mu(p', p)$ is sandwiched by the Dirac fields as $\bar{u}(p')\Gamma_{(1)}^\mu(p', p)u(p)$. Since $\Gamma_{(1)}^\mu(p', p)$ has an infrared divergence, we have introduced a small photon mass λ .

With help of FeynCalc, we evaluate

$$S^\mu \equiv (2\pi\mu)^{4-n} \int d^n k \frac{\gamma^\nu (\not{k} + \not{q} + m) \gamma^\mu (\not{k} + m) \gamma_\nu}{((k+q)^2 - m^2)(k^2 - m^2)((p-k)^2 - \lambda^2)}\quad (79)$$

- Using the on-shell conditions for the Dirac field: $\bar{u}(p+q)(\not{p} + \not{q}) = \bar{u}(p+q)m$ and $\not{p}u(p) = mu(p)$, we find

$$\begin{aligned}\bar{u}(p+q)(\not{p}\not{q}\gamma^\mu)u(p) &= \bar{u}(p+q)\{(2m^2 - q^2)\gamma^\mu - 2mp^\mu\}u(p) \\ \bar{u}(p+q)(\not{q})u(p) &= 0 \\ \bar{u}(p+q)(\not{p})u(p) &= m \bar{u}(p+q)u(p)\end{aligned}\quad (80)$$

Thus, in evaluation of S^μ , we perform the following replacements:

$$\begin{aligned}\not{p}\not{q}\gamma^\mu &\implies (2m^2 - q^2)\gamma^\mu - 2mp^\mu \\ \not{q} &\implies 0 \\ \not{p} &\implies m\end{aligned}$$

- We obtain

$$\begin{aligned}S^\mu / (i\pi^2) &= \gamma^\mu \left\{ (4m^2 - 2q^2)C_0(m^2, q^2, m^2; \lambda^2, m^2, m^2) - 3B_0(q^2; m^2, m^2) \right. \\ &\quad \left. + 4B_0(m^2; m^2, \lambda^2) - 2 \right\} \\ &\quad + \frac{m}{4m^2 - q^2} (2p^\mu + q^\mu) \left\{ 2B_0(q^2; m^2, m^2) - 4B_0(m^2; m^2, \lambda^2) \right. \\ &\quad \left. + 2B_0(0; m^2, \lambda^2) + 2 \right\}\end{aligned}\quad (81)$$

Infrared divergence does not appear in the two-point integrals B_0 's but in the three-point integral $C_0(m^2, q^2, m^2; \lambda^2, m^2, m^2)$, and so we set $\lambda^2 = 0$ in the B_0 's.

- Again using the on-shell conditions for the Dirac field, we can show the Gordon identity:

$$\bar{u}(p+q)\gamma^\mu u(p) = \bar{u}(p+q)\left[\frac{2p^\mu + q^\mu}{2m} + \frac{i\sigma^{\mu\nu}q_\nu}{2m}\right]u(p) \quad (82)$$

where $\sigma^{\mu\nu} \equiv \frac{i}{2}[\gamma^\mu, \gamma^\nu]$. Thus we replace $(2p^\mu + q^\mu)$ in Eq.(81) as follows:

$$(2p^\mu + q^\mu) \implies 2m\gamma^\mu - i\sigma^{\mu\nu}q_\nu \quad (83)$$

- Then $\Gamma_{(1)}^\mu(p', p)$ is rewritten in the form as

$$\Gamma_{(1)}^\mu(p', p) = \gamma^\mu \delta F_1^{(1)}(q^2) + \frac{i\sigma^{\mu\nu}q_\nu}{2m} \delta F_2^{(1)}(q^2) \quad (84)$$

where

$$\begin{aligned} \delta F_1^{(1)}(q^2) &= \frac{e^2}{16\pi^2} \left\{ (4m^2 - 2q^2)C_0(m^2, q^2, m^2; \lambda^2, m^2, m^2) - 3B_0(q^2; m^2, m^2) \right. \\ &\quad \left. + 4B_0(m^2; m^2, 0) - 2 \right. \\ &\quad \left. + \frac{2m^2}{4m^2 - q^2} \left\{ 2B_0(q^2; m^2, m^2) - 4B_0(m^2; m^2, 0) + 2B_0(0; m^2, 0) + 2 \right\} \right\} \quad (85) \end{aligned}$$

$$\delta F_2^{(1)}(q^2) = -\frac{e^2}{16\pi^2} \frac{2m^2}{4m^2 - q^2} \left\{ 2B_0(q^2; m^2, m^2) - 4B_0(m^2; m^2, 0) + 2B_0(0; m^2, 0) + 2 \right\} \quad (86)$$

- At $q^2 = 0$, we get from (333), (337), (338) and (342)

$$\begin{aligned} \delta F_1^{(1)}(0) &= \frac{e^2}{16\pi^2} \left\{ 4m^2 C_0(m^2, 0, m^2; \lambda^2, m^2, m^2) - 2B_0(0; m^2, m^2) \right. \\ &\quad \left. + 2B_0(m^2; m^2, 0) + B_0(0; m^2, 0) - 1 \right\} \\ &= \frac{e^2}{16\pi^2} \left(\frac{4\pi\mu^2}{m^2} \right)^\epsilon e^{-\epsilon\gamma_E} \left\{ \frac{1}{\epsilon} + 4 + 2 \log \frac{\lambda^2}{m^2} \right\} \quad (87) \end{aligned}$$

$$\begin{aligned} \delta F_2^{(1)}(0) &= -\frac{e^2}{16\pi^2} \frac{1}{2} \left\{ 2B_0(0; m^2, m^2) - 4B_0(m^2; m^2, 0) + 2B_0(0; m^2, 0) + 2 \right\} \\ &= \frac{e^2}{16\pi^2} \times 2 \quad (88) \end{aligned}$$

- Renormalization constants $Z_1^{(1)}(\alpha)$:

The renormalization condition requires $\delta F_1^{(1)}(q^2 = 0) + Z_1^{(1)}(\alpha) = 0$

Then we obtain (setting $\mu^2 = m^2$)

$$Z_1^{(1)}(\alpha) = -\frac{\alpha}{4\pi} S^\epsilon \left\{ \frac{1}{\epsilon} + 4 + 2 \log \frac{\lambda^2}{m^2} \right\} \quad (89)$$

◇ From (77) and (89), we see $Z_2^{(1)}(\alpha) = Z_1^{(1)}(\alpha)$

In fact, we obtain $Z_2 = Z_1$ to all orders in perturbative QED, which follows from the Ward-Takahashi identity, a consequence of gauge invariance.

2.6.4 The effective coupling constant $\alpha_{\text{eff}}(q^2)$

Ref. Peskin and Schroeder, Chap.7

- The relation between the bare and physical (or renormalized) electric charge: $e_0 Z_2 Z_3^{1/2} = e Z_1$ in Eq.(41) and the result of the Ward identity $Z_1 = Z_2$

$$e_0 Z_3^{1/2} = e \quad (90)$$



Figure 3: The exact photon two-point function

- Using the QED Lagrangian given in Eq.(39) with bare fields and bare charge e_0 , the exact photon two-point function $A_{\mu\nu}(q)$ depicted in Fig.3 is

$$\begin{aligned} A_{\mu\nu}(q) &= \frac{-ig_{\mu\nu}}{q^2} + \frac{-ig_{\mu\rho}}{q^2} \left[i(q^2 g^{\rho\tau} - q^\rho \tau) \Pi(q^2, e_0^2) \right] \frac{-ig_{\tau\nu}}{q^2} + \dots \\ &= \frac{-ig_{\mu\nu}}{q^2} + \frac{-ig_{\mu\rho}}{q^2} \left(g^\rho{}_\nu - \frac{q^\rho q_\nu}{q^2} \right) \left(\Pi(q^2, e_0^2) + \Pi^2(q^2, e_0^2) + \dots \right) \\ &= \frac{-i}{q^2(1 - \Pi(q^2, e_0^2))} \left(g_{\mu\nu} - \frac{q_\mu q_\nu}{q^2} \right) + \frac{-iq_\mu q_\nu}{(q^2)^2} \end{aligned} \quad (91)$$

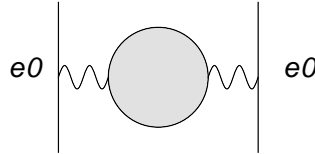

Figure 4: The photon two-point function attached to conserved currents

- When $A_{\mu\nu}(q)$ is attached to a conserved electric current $j^\mu(j^\nu)$ at each end with a bare electric coupling constant e_0 (see Fig.4), we obtain (note $q_\mu j^\mu = 0$)

$$\frac{-ie_0^2 g_{\mu\nu}}{(1 - \Pi(q^2, e_0^2))q^2} \quad (92)$$

- Deviding $\Pi(q^2, e_0^2)$ into two pieces, $\Pi(0, e_0^2)$ and $\hat{\Pi}(q^2, e_0^2) \equiv \Pi(q^2, e_0^2) - \Pi(0, e_0^2)$. The divergent part is included in $\Pi(0, e_0^2)$. $\hat{\Pi}(q^2, e_0^2)$ is a finite function of q^2 and $\hat{\Pi}(q^2 = 0, e_0^2) = 0$. We define

$$Z_3 \equiv \frac{1}{1 - \Pi(0, e_0^2)} \quad (93)$$

and rewrite $e_0^2/(1 - \Pi(q^2, e_0^2))$ as

$$\begin{aligned} \frac{e_0^2}{1 - \Pi(q^2, e_0^2)} &= \frac{e_0^2}{1 - \{\Pi(0, e_0^2) + \widehat{\Pi}(q^2, e_0^2)\}} = \frac{e_0^2}{1 - \Pi(q^2, e_0^2)} \frac{1}{1 - \frac{\widehat{\Pi}(q^2, e_0^2)}{1 - \Pi(q^2, e_0^2)}} \\ &= \frac{e_0^2 Z_3}{1 - \frac{\widehat{\Pi}(q^2, e_0^2)}{1 - \Pi(q^2, e_0^2)}} = \frac{e^2}{1 - \frac{\widehat{\Pi}(q^2, e_0^2)}{1 - \Pi(q^2, e_0^2)}} \end{aligned} \quad (94)$$

where, in the last line, Eq.(90) was used.

Also $\widehat{\Pi}(q^2, e_0^2)/(1 - \Pi(q^2, e_0^2))$ is rewritten as

$$\frac{\widehat{\Pi}(q^2, e_0^2)}{1 - \Pi(q^2, e_0^2)} = \widehat{\Pi}(q^2, e^2) \quad (95)$$

where e_0^2 in $\widehat{\Pi}(q^2, e_0^2)$ is replaced with the renormalized electric coupling constant e^2 . We have already seen the above statement is true in one-loop order.

In fact, we expand the r.h.s. of Eq.(93) as $Z_3 = 1 + \Pi(0, e_0^2) + \Pi(0, e_0^2)^2 + \dots$ and we see from Eq.(69) that at one-loop order,

$$Z_3 - 1 = Z_3^{(1)}(\alpha) = \Pi_1(0, e^2) = \Pi(0, e_0^2) \Big|_{\text{one-loop}} + \mathcal{O}(\alpha^2) \quad (96)$$

- The effective coupling constant: $\alpha_{\text{eff}}(q^2) = \frac{e^2/(4\pi)}{1 - \widehat{\Pi}(q^2, e^2)}$
 Since $\widehat{\Pi}(q^2 = 0, e^2) = 0$, we have $\alpha_{\text{eff}}(q^2 = 0) = e^2/(4\pi) = \alpha$, which is observed experimentally to be $1/137$. But $\alpha_{\text{eff}}(q^2)$ will change with q^2 , in other words, it varies depending on at which scale it is observed. If $-q^2 \gg m_e^2$ or, at small distance, we plug in the one-loop result (68) and obtain

$$\alpha_{\text{eff}}(q^2) = \frac{\alpha}{1 - \frac{\alpha}{3\pi} \left(\log \frac{-q^2}{m^2} - \frac{5}{3} \right)} = \frac{\alpha}{1 - \frac{\alpha}{3\pi} \left(\log \frac{-q^2}{Am^2} \right)} \quad (97)$$

The effective electric charge becomes much larger at small distances.

3 Quantum Chromodynamics (QCD)

3.1 Color degrees of freedom

◇ In addition to the flavor quantum number (up, down, strange, charm, top and bottom), quarks have a hidden quantum number, color $SU(3)$

- Low-lying baryon states

$$|\Delta^{++}, J_3 = \frac{3}{2}\rangle = |u \uparrow, u \uparrow, u \uparrow\rangle \quad (98)$$

The state should be antisymmetric with respect to the exchange of quarks \implies need to introduce a hidden degrees of freedom, color

$$|\Delta^{++}, J_3 = \frac{3}{2}\rangle = \varepsilon_{ijk} |u^i \uparrow, u^j \uparrow, u^k \uparrow\rangle \quad (99)$$

- Quark confinement postulate:

Baryon states are constructed out of three quarks while meson states made out of quark-antiquark pairs. Diquark and four-quark states have not been observed.

$$\mathbf{3} \otimes \mathbf{3} \otimes \mathbf{3} = \mathbf{1} \oplus \mathbf{8} \oplus \mathbf{8} \oplus \mathbf{10}, \quad \mathbf{3} \otimes \mathbf{3}^* = \mathbf{1} \oplus \mathbf{8}$$

(Color singlets cannot be made out of diquark and four-quark states.)

All hadron states and physical observables are color singlets

- $\pi^0 \rightarrow 2\gamma$ decays

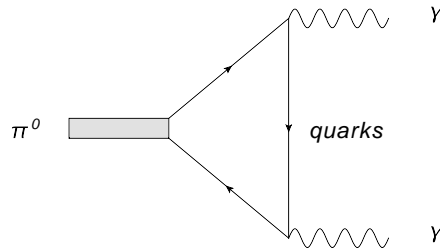

Figure 5: $\pi^0 \rightarrow 2\gamma$

$$\Gamma(\text{exp}) \approx N_C^2 \times \Gamma(\pi^0 \rightarrow 2\gamma : \text{no color degrees of freedom}) \quad (100)$$

with $N_C = 3$, where N_C is the number of colors.

- R ratio

$$\begin{aligned}
R &= \frac{\sigma(e^+e^- \rightarrow \text{hadrons})}{\sigma(e^+e^- \rightarrow \mu^+\mu^-)} \\
&= N_C \sum_{i=1}^{N_f} Q_i^2 .
\end{aligned} \tag{101}$$

Experimental data support for $N_C = 3$.

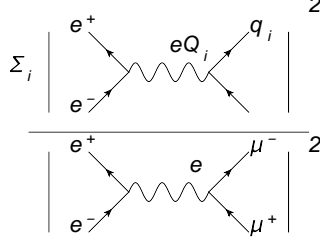

Figure 6: $\sigma(e^+e^- \rightarrow \text{hadrons})$ vs. $\sigma(e^+e^- \rightarrow \mu^+\mu^-)$

3.2 Classical Lagrangian of QCD

- ◇ Assign color degrees of freedom (red, yellow, blue) to each flavor of quark and impose that a theory should be invariant under local gauge transformations of these quark fields

$$\begin{aligned}
\begin{pmatrix} \psi_{q(\text{red})} \\ \psi_{q(\text{yellow})} \\ \psi_{q(\text{blue})} \end{pmatrix} &\longrightarrow \begin{pmatrix} 3 \times 3 \\ SU(3) \\ \text{matrix} \end{pmatrix} \begin{pmatrix} \psi_{q(\text{red})} \\ \psi_{q(\text{yellow})} \\ \psi_{q(\text{blue})} \end{pmatrix} \\
&= \exp \left[-i \sum_{a=1}^8 T^a \theta^a(x) \right] \begin{pmatrix} \psi_{q(\text{red})} \\ \psi_{q(\text{yellow})} \\ \psi_{q(\text{blue})} \end{pmatrix}
\end{aligned} \tag{102}$$

where T^a are the matrices of the fundamental representation of $SU(3)$ and are expressed as

$$T^a = \frac{\lambda^a}{2} \tag{103}$$

$$\begin{aligned}
\lambda^1 &= \begin{pmatrix} 0 & 1 & 0 \\ 1 & 0 & 0 \\ 0 & 0 & 0 \end{pmatrix}, & \lambda^2 &= \begin{pmatrix} 0 & -i & 0 \\ i & 0 & 0 \\ 0 & 0 & 0 \end{pmatrix}, & \lambda^3 &= \begin{pmatrix} 1 & 0 & 0 \\ 0 & -1 & 0 \\ 0 & 0 & 0 \end{pmatrix}, \\
\lambda^4 &= \begin{pmatrix} 0 & 0 & 1 \\ 0 & 0 & 0 \\ 1 & 0 & 0 \end{pmatrix}, & \lambda^5 &= \begin{pmatrix} 0 & 0 & -i \\ 0 & 0 & 0 \\ i & 0 & 0 \end{pmatrix}, & \lambda^6 &= \begin{pmatrix} 0 & 0 & 0 \\ 0 & 0 & 1 \\ 0 & 1 & 0 \end{pmatrix},
\end{aligned}$$

$$\lambda^7 = \begin{pmatrix} 0 & 0 & 0 \\ 0 & 0 & -i \\ 0 & i & 0 \end{pmatrix}, \quad \lambda^8 = \begin{pmatrix} \frac{1}{\sqrt{3}} & 0 & 0 \\ 0 & \frac{1}{\sqrt{3}} & 0 \\ 0 & 0 & -\frac{2}{\sqrt{3}} \end{pmatrix} \quad (104)$$

- Note that $SU(3)$ is a non-Abelian (noncommutative) group.
- T^a is a generator of $SU(3)$ group which satisfies

$$[T^a, T^b] = i f^{abc} T^c, \quad f^{abc} : \text{structure constants} \quad (105)$$

- To maintain the gauge invariance, we need an introduction of gauge bosons (color-gluons) A_μ^a ($a = 1, \dots, 8$), (Yang and Mills, 1954)
- We obtain for classical Lagrangian of QCD

$$\mathcal{L}_C = -\frac{1}{4} F_{\mu\nu}^a F^{a\mu\nu} + \sum_q \bar{\psi}_q (i\gamma^\mu D_\mu - m_q) \psi_q \quad (106)$$

where

$$\psi_q = \begin{pmatrix} \psi_{q(\text{red})} \\ \psi_{q(\text{yellow})} \\ \psi_{q(\text{blue})} \end{pmatrix} \quad (107)$$

$$F_{\mu\nu}^a = \partial_\mu A_\nu^a - \partial_\nu A_\mu^a + g f^{abc} A_\mu^b A_\nu^c \quad (108)$$

$$D_\mu = \partial_\mu - ig T^a A_\mu^a \quad (109)$$

T^a : the generators of $SU(3)$ ($a = 1, \dots, 8$)

[for $SU(N)$, $a = 1, \dots, N^2 - 1$]

f^{abc} : the structure constants of $SU(3)$; $[T^a, T^b] = i f^{abc} T^c$

g : the gauge coupling constant

- \mathcal{L}_C is invariant under the following local gauge transformation,

$$\begin{aligned} \psi &\rightarrow \psi' = U\psi & (\psi'_i = U_{ij}\psi_j) & \text{ with } U = e^{-iT^a\theta^a} \\ T^a A_\mu^a &\rightarrow T^a A'_\mu^a = U(T^a A_\mu^a - \frac{i}{g} U^{-1} \partial_\mu U) U^{-1} \end{aligned} \quad (110)$$

In fact, we have

$$\begin{aligned} \bar{\psi} &\rightarrow \bar{\psi} U^{-1} \\ D_\mu \psi &\rightarrow (\partial_\mu - ig T^a A'_\mu^a) \psi' \\ &= U(\partial_\mu + U^{-1} \partial_\mu U - ig U^{-1} T^a A_\mu^a U) \psi \\ &= U(\partial_\mu - ig T^a A_\mu^a) \psi = U D_\mu \psi \\ T^a F_{\mu\nu}^a &\rightarrow U T^a F_{\mu\nu}^a U^{-1} \end{aligned} \quad (111)$$

$$\begin{aligned}
\mathbf{A}_\mu &\equiv T^a A_\mu^a, & \mathbf{A}_\mu \rightarrow \mathbf{A}'_\mu &= U \mathbf{A}_\mu U^{-1} - \frac{i}{g} (\partial_\mu U) U^{-1} \\
\mathbf{F}_{\mu\nu} &\equiv T^a F_{\mu\nu}^a = \partial_\mu \mathbf{A}_\nu - \partial_\nu \mathbf{A}_\mu + \frac{g}{i} [\mathbf{A}_\mu, \mathbf{A}_\nu] & & (112) \\
\mathbf{F}_{\mu\nu} &\rightarrow U \mathbf{F}_{\mu\nu} U^{-1}, & \text{Tr}(\mathbf{F}_{\mu\nu} \cdot \mathbf{F}^{\mu\nu}) &= \frac{1}{2} F_{\mu\nu}^a F^{a\mu\nu}
\end{aligned}$$

◇ Gluons (gauge fields) have color charge by themselves, thus they interact among themselves

$$-\frac{1}{4} F_{\mu\nu}^a F^{a\mu\nu} \implies \begin{cases} -g f^{abc} (\partial_\mu A_\nu^a) A^{b\mu} A^{c\nu} \\ -\frac{1}{4} g^2 f^{abc} f^{ade} A_\mu^b A_\nu^c A^{d\mu} A^{e\nu} \end{cases} \quad (113)$$

- A remarkable feature of non-Abelian gauge theories.
- The self-interactions among gluons are the main source of asymptotic freedom in QCD.

3.3 Quantization

3.3.1 The gauge fixing

We must fix the gauge. We add to \mathcal{L}_C

$$\mathcal{L}_{GF} = -\frac{1}{2\xi} (G^a)^2 \quad (114)$$

where

$$\begin{aligned}
G^a &= 0 && \text{Gauge fixing conditions} \\
\xi &: && \text{Gauge parameter}
\end{aligned}$$

Examples:

$$\begin{aligned}
\partial^\mu A_\mu^a &= 0 && \text{Covariant gauge} \\
&&& (\xi = 1 \text{ Feynman gauge}, \quad \xi = 0 \text{ Landau gauge}) \\
\partial_i A_i^a &= 0 && \text{Coulomb gauge}
\end{aligned}$$

3.3.2 Introduction of the Faddeev-Popov ghost

- If we calculate gluon loop diagrams using, naively, the usual Feynman rules for the gluon propagators and three-gluon vertices obtained from the sum of the Lagrangians $\mathcal{L}_C + \mathcal{L}_{GF}$, we would include the redundant degrees of freedom of gluons, which should be discarded.

In covariant gauge

$$\mathcal{L}_{FP} = (\partial^\mu \chi^{a*}) D_\mu^{ab} \chi^b \quad (115)$$

with $D_\mu^{ab} = \delta^{ab} \partial_\mu - g f^{abc} A_\mu^c$.

χ^a : The Faddeev-Popov ghost

It is fermionic (Grassmann number) as well as bosonic (its propagator is boson-like).

3.3.3 QCD Lagrangian

$$\mathcal{L}_{QCD} = \mathcal{L}_C + \mathcal{L}_{GF} + \mathcal{L}_{FP} \quad (116)$$

where \mathcal{L}_C , \mathcal{L}_{GF} and \mathcal{L}_{FP} are given in Eqs.(106), (114) and (115), respectively.

- \mathcal{L} is not invariant anymore under the gauge transformation (110).
- But \mathcal{L} is invariant under BRS (Becchi-Rouet-Stora) transformation, from which Slavnov-Taylor identity is derived.

[BRS transformation]

Choose two real ghost fields χ_1^a and χ_2^a in place of χ^a and χ^{a*}
(two choices are equivalent):

$$\chi^a = (\chi_1^a + i\chi_2^a)/\sqrt{2} \quad \Rightarrow \quad \mathcal{L}_{FP} = i(\partial^\mu \chi_1^a) D_\mu^{ab} \chi_2^a \quad (117)$$

- \mathcal{L}_C is invariant under infinitesimal local gauge transformation ($\delta\theta^a$)

$$\begin{aligned} \delta\psi &= -i\delta\theta^a T^a \psi \\ \delta A_\mu^a &= f^{abc} \delta\theta^b A_\mu^c - \frac{1}{g} \partial_\mu \delta\theta^a = -\frac{1}{g} D_\mu^{ab} \delta\theta^b \end{aligned} \quad (118)$$

- Introducing an infinitesimal Grassmann number $\delta\lambda$ independent of x

($\{\delta\lambda, \chi_2^a(x)\} = 0$) and assume the following local gauge transformation

$$\begin{aligned}\delta\theta^a(x) &= -g\delta\lambda \chi_2^a(x) \\ \delta\chi_1^a(x) &= i\delta\lambda \frac{1}{\xi} \partial^\mu A_\mu^a(x) \\ \delta\chi_2^a(x) &= -\frac{1}{2}\delta\lambda g f^{abc} \chi_2^a(x) \chi_2^b(x)\end{aligned}\tag{119}$$

- $(\mathcal{L}_{GF} + \mathcal{L}_{FP})$ remains invariant as well as \mathcal{L}_C .

[Slavnov-Taylor identity] \Rightarrow relations among the renormalization constants
 \Rightarrow the universality of the renormalized coupling constant g_R

3.3.4 Feynman rules in QCD

The QCD Lagrangian \mathcal{L}_{QCD} is decomposed into a free part \mathcal{L}_0 and an interaction part \mathcal{L}_I . We take a covariant gauge.

$$\mathcal{L}_{QCD} = \mathcal{L}_0 + \mathcal{L}_I ,\tag{120}$$

$$\begin{aligned}\mathcal{L}_0 &= -\frac{1}{4}(\partial_\mu A_\nu^a - \partial_\nu A_\mu^a)(\partial^\mu A^{a\nu} - \partial^\nu A^{a\mu}) - \frac{1}{2\xi}(\partial^\mu A_\mu^a)^2 \\ &\quad + (\partial^\mu \chi^{a*})(\partial_\mu \chi^a) + \sum_q \bar{\psi}_q (i\gamma^\mu \partial_\mu - m_q) \psi_q\end{aligned}\tag{121}$$

$$\begin{aligned}\mathcal{L}_I &= -g f^{abc} (\partial_\kappa A_\lambda^a) A^{b\kappa} A^{c\lambda} - \frac{1}{4} g^2 f^{eab} f^{ecd} A_\kappa^a A_\lambda^b A^{c\kappa} A^{d\lambda} \\ &\quad + g f^{abc} (\partial^\mu \chi^{a*}) A_\mu^b \chi^c + g \sum_q \bar{\psi}_q \gamma^\mu T^a \psi_q A_\mu^a\end{aligned}\tag{122}$$

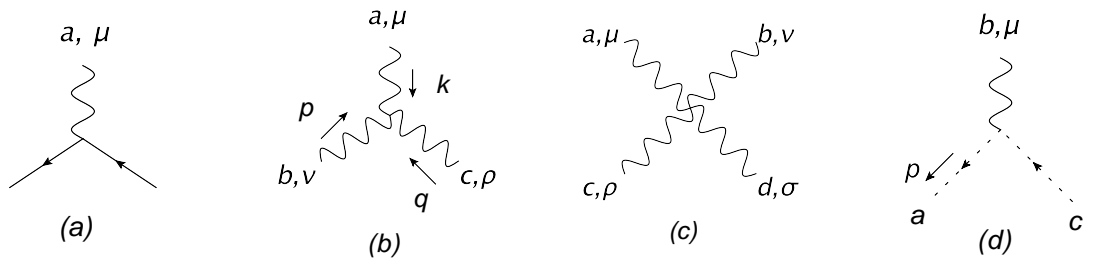

Figure 7: (a) Quark-gluon vertex; (b) 3-gluon vertex; (c) 4-gluon vertex; (d) Gluon-ghost vertex.

1. Propagators

- gluon propagator: $\tilde{D}_{\mu\nu}^{ab}(k) = \frac{-i}{k^2 + i\epsilon} \left[g^{\mu\nu} - (1 - \xi) \frac{k^\mu k^\nu}{k^2} \right] \delta^{ab}$

– Feynman gauge: $\xi = 1$, Landau gauge: $\xi = 0$

- quark propagator: $\tilde{S}_q^{ab}(p) = \frac{i\delta^{ab}}{\not{p} - m_q + i\epsilon}$
- ghost propagator: By partial integration, $(\partial^\mu \chi^{a*})(\partial_\mu \chi^b) \implies \chi^{a*}(-\partial^2)\chi^b$
Solving $(-\partial^2)D_{FP}^{ab}(x-y) = i\delta^{ab}\delta^4(x-y)$, we obtain

$$D_{FP}^{ab}(x-y) = \int \frac{d^4p}{(2\pi)^4} \frac{i\delta^{ab}}{p^2 + i\epsilon} e^{-ip \cdot (x-y)}$$

In momentum space, the ghost propagator is expressed as $\tilde{S}_{FP}^{ab}(p) = \frac{i\delta^{ab}}{p^2 + i\epsilon}$

2. Vertices

- (a) quark-gluon vertex: $ig\gamma^\mu T^a$
- (b) three-gluon vertex: $gf^{abc} V^{\mu\nu\rho}(k, p, q)$

where

$$V^{\mu\nu\rho}(k, p, q) \equiv g^{\mu\nu}(k-p)^\rho + g^{\nu\rho}(p-q)^\mu + g^{\rho\mu}(q-k)^\nu \quad (123)$$

- (c) four-gluon vertex: $-ig^2 W_{\mu\nu\rho\sigma}^{abcd}$

where

$$\begin{aligned} W_{\mu\nu\rho\sigma}^{abcd} \equiv & f^{abe} f^{cde} (g^{\mu\rho} g^{\nu\sigma} - g^{\mu\sigma} g^{\nu\rho}) + f^{ace} f^{bde} (g^{\mu\nu} g^{\rho\sigma} - g^{\mu\sigma} g^{\nu\rho}) \\ & + f^{ade} f^{bce} (g^{\mu\nu} g^{\rho\sigma} - g^{\mu\rho} g^{\nu\sigma}) \end{aligned} \quad (124)$$

- (d) gluon-ghost vertex: $-gf^{abc}p^\mu$

3.4 Renormalization of QCD

Ref. Peskin and Schroeder, Chap.16

◇ QCD is a renormalizable perturbation theory. The divergences can be removed by a finite number of counterterms.

- The original QCD Lagrangian is assumed to be written by a combination of bare fields $\psi_{q,\text{bare}}$, $A_{\text{bare}}^{a\mu}$ and χ_{bare}^a , bare masses m_{q0} and a bare coupling constant g_0 :

$$\mathcal{L}_{QCD} \longrightarrow \tilde{\mathcal{L}}_{QCD} = \mathcal{L}_{QCD}(\psi_{q,\text{bare}}, A_{\text{bare}}^{a\mu}, \chi_{\text{bare}}^a, m_{q0}, g_0) \quad (125)$$

- Rescale the bare fields with the renormalized fields ψ_q , A_μ^a and χ^a as

$$\psi_{q,\text{bare}} = Z_2^{1/2} \psi_q, \quad A_{\text{bare}}^{a\mu} = Z_3^{1/2} A^{a\mu}, \quad \chi_{\text{bare}}^a = \tilde{Z}_2^{1/2} \chi^a \quad (126)$$

together with

$$\begin{aligned} Z_2 m_{q0} &= m_q + \delta m_q, & g_0 Z_2 Z_3^{1/2} &= g Z_1, \\ g_0 \tilde{Z}_2 Z_3^{1/2} &= g Z_1^{FP}, & g_0 Z_3^{3/2} &= g Z_1^{3g}, & g_0^2 Z_3^2 &= g^2 Z_1^{4g} \end{aligned} \quad (127)$$

where m_{q0} is a renormalized mass and g is a renormalized coupling constant. Then $\tilde{\mathcal{L}}_{QCD}$ is rewritten as

$$\tilde{\mathcal{L}}_{QCD} = \mathcal{L}_{ren0} + \mathcal{L}_{renI} + \mathcal{L}_{c.t.} \quad (128)$$

where \mathcal{L}_{ren0} and \mathcal{L}_{renI} are the same as \mathcal{L}_0 and \mathcal{L}_I given in Eqs.(121) and (122), respectively, while $\mathcal{L}_{c.t.}$ is expressed as

$$\begin{aligned} \mathcal{L}_{c.t.} &= -\frac{1}{4}(Z_3 - 1)(\partial_\mu A_\nu^a - \partial_\nu A_\mu^a)^2 + (\tilde{Z}_2 - 1)(\partial^\mu \chi^{a*})(\partial_\mu \chi^b) \\ &\quad + \sum_q \bar{\psi}_q (i[Z_2 - 1]\not{\partial} - \delta m_q) \psi_q \\ &\quad - g(Z_1^{3g} - 1) f^{abc} (\partial_\mu A_\nu^a) A^{b\mu} A^{c\nu} - \frac{1}{4} g^2 (Z_1^{4g} - 1) f^{abc} f^{ade} A_\mu^b A_\nu^c A^{d\mu} A^{e\nu} \\ &\quad + g(Z_1^{FP} - 1) f^{abc} (\partial^\mu \chi^{a*}) A_\mu^b \chi^c + g(Z_1 - 1) \sum_q \bar{\psi}_q \gamma^\mu T^a \psi_q A_\mu^a \end{aligned} \quad (129)$$

- In momentum space, the counterterms are expressed as

$$\begin{aligned} i(Z_3 - 1) \frac{1}{2} A_\mu^a(x) (\partial^2 g^{\mu\nu} - \partial^\mu \partial^\nu) A_\nu^b(x) &\implies -i(Z_3 - 1) (g^{\mu\nu} q^2 - q^\mu q^\nu) \delta^{ab} \\ i(\tilde{Z}_2 - 1) (\partial^\mu \chi^{a*})(\partial_\mu \chi^b) &\implies i(\tilde{Z}_2 - 1) p^2 \delta^{ab} \\ i\bar{\psi}_q (i[Z_2 - 1]\not{p} - \delta m_q) \psi_q &\implies i((Z_2 - 1)\not{p} - \delta m_q) \\ -ig(Z_1^{3g} - 1) f^{abc} (\partial_\mu A_\nu^a) A^{b\mu} A^{c\nu} &\implies g(Z_1^{3g} - 1) f^{abc} V^{\mu\nu\rho}(k, p, q) \\ -\frac{1}{4} ig^2 (Z_1^{4g} - 1) f^{abc} f^{ade} A_\mu^b A_\nu^c A^{d\mu} A^{e\nu} &\implies -ig^2 (Z_1^{4g} - 1) W_{\mu\nu\rho\sigma}^{abcd} \\ -ig(Z_1^{FP} - 1) f^{abc} (\partial^\mu \chi^{a*}) A_\mu^b \chi^c &\implies -g(Z_1^{FP} - 1) f^{abc} p^\mu \\ ig(Z_1 - 1) \sum_q \bar{\psi}_q \gamma^\mu T^a \psi_q A_\mu^a &\implies ig(Z_1 - 1) \gamma^\mu T^a \end{aligned} \quad (130)$$

- Renormalization constants $Z_i = (Z_2, Z_3, \tilde{Z}_2, Z_1, Z_1^{FP}, Z_1^{3g}, Z_1^{4g})$ and mass shift δm_q are expanded in powers of $\alpha_s = g^2/(4\pi)$ as

$$Z_i = 1 + Z_i^{(1)}(\alpha_s) + Z_i^{(2)}(\alpha_s^2) + \dots, \quad (131)$$

$$\delta m_q = m_q \left(\delta_m^{(1)}(\alpha_s) + \delta_m^{(2)}(\alpha_s^2) + \dots \right) \quad (132)$$

- From Eq.(127), we see there hold the three relations among the renormalization constants

$$\frac{g_0}{g} = \frac{Z_1}{Z_2 Z_3^{1/2}} = \frac{Z_1^{FP}}{\tilde{Z}_2 Z_3^{1/2}} = \frac{Z_1^{3g}}{Z_3^{3/2}} = \frac{(Z_1^{4g})^{1/2}}{Z_3}$$

which are rewritten as

$$\frac{Z_1}{Z_2} = \frac{Z_1^{FP}}{\tilde{Z}_2} = \frac{Z_1^{3g}}{Z_3} = \frac{Z_1^{4g}}{Z_3^{3g}}. \quad (133)$$

The above equation is called the Slavnov-Taylor identity which, conversely, guarantees the universality of the renormalized coupling constant g .

- In terms of the renormalization constants $Z_i^{(1)}(\alpha_s)$ in one-loop order, the above three relations are expressed as

$$Z_1^{(1)} - Z_2^{(1)} = Z_1^{FP(1)} - \tilde{Z}_2^{(1)} = Z_1^{3g(1)} - Z_3^{(1)} = Z_1^{4g(1)} - Z_3^{3g(1)} \quad (134)$$

3.5 One-loop calculation of

$$Z_3^{(1)}, Z_2^{(1)}, Z_1^{(1)}, \tilde{Z}_2^{(1)}, Z_1^{FP(1)}, Z_1^{3g(1)}, Z_1^{4g(1)}$$

3.5.1 $\overline{\text{MS}}$ (Minimal Subtraction) renormalization scheme

- [[$\overline{\text{MS}}$ renormalization scheme]]
 - Adding counterterms to cancel pole-terms proportional to $\frac{1}{\epsilon}$, which appear in dimensional regularization when $n \rightarrow 4$.
 - Counterterms have no finite terms.
- [[$\overline{\text{MS}}$ renormalization scheme]]
 - Subtract a term proportional to $\left(\frac{1}{\epsilon} - \gamma_E + \log 4\pi\right)$
 - The terms $\left(\frac{1}{\epsilon} - \gamma_E + \log 4\pi\right)$ can be expressed as

$$S^\epsilon \frac{1}{\epsilon}, \quad \text{with} \quad S^\epsilon \equiv (4\pi)^\epsilon e^{-\epsilon\gamma_E} \quad (135)$$

- ◇ In the following, we calculate the QCD renormalization constants in one-loop order in $\overline{\text{MS}}$ scheme. We choose Feynman gauge $\xi = 1$ for gluon propagator. Since quark mass is irrelevant to the ultraviolet divergence, we put $m = 0$ for the calculation of the QCD renormalization constants in $\overline{\text{MS}}$ scheme.

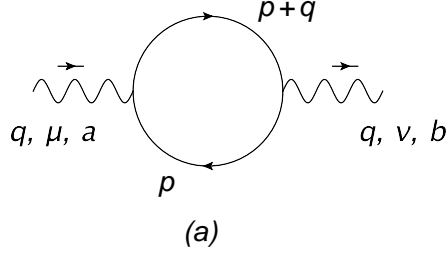

Figure 8: Gluon self-energy (quark-loop)

3.5.2 Gluon Self-energy $Z_3^{(1)}(\alpha_s)$

Four one-loop diagrams contribute to the gluon self-energy $i\Pi_{\mu\nu}^{ab(1)}(q)$.

1. Quark-loop contribution:

$$i\Pi_{\mu\nu}^{ab(1)}(q) = \sum_{quark} (ig\mu^\epsilon)^2 \text{tr}[T^a T^b] (-1) \int \frac{d^n p}{(2\pi)^n} \text{Tr} \left[\gamma^\mu \frac{i}{\not{p}} \gamma^\nu \frac{i}{\not{p} + \not{q}} \right] \quad (136)$$

- With help of FeynCalc, we obtain

$$(2\pi\mu)^{4-n} \int d^n p \frac{\text{Tr}[\gamma^\mu \not{p} \gamma^\nu (\not{p} + \not{q})]}{p^2 (p+q)^2} = i\pi^2 (q^2 g^{\mu\nu} - q^\mu q^\nu) \left\{ \frac{4}{3} B_0(q^2; 0, 0) - \frac{4}{9} \right\} \quad (137)$$

- Thus we find

$$i\Pi_{\mu\nu}^{ab(1)}(q) = i(q^2 g^{\mu\nu} - q^\mu q^\nu) \delta^{ab} \frac{-g^2}{16\pi^2} n_f T_R \left\{ \frac{4}{3} B_0(q^2; 0, 0) - \frac{4}{9} \right\} \quad (138)$$

where $\text{tr}[T^a T^b] = T_R \delta^{ab}$ with $T_R = \frac{1}{2}$, and n_f is the number of quark flavors.

- From the expression of $B_0(q^2; 0, 0)$ given in Eq.(332), we obtain

$$Z_{3(quark)}^{(1)} = \frac{-g^2}{16\pi^2} S^\epsilon \frac{1}{\epsilon} \frac{4}{3} n_f T_R \quad (139)$$

2. Gluon-loop contribution 1

$$i\Pi_{\mu\nu}^{ab(1)}(q) = \frac{1}{2} (g\mu^\epsilon)^2 \int \frac{d^n p}{(2\pi)^n} \frac{-i}{p^2} \frac{-i}{(p+q)^2} \times f^{acd} V^{\mu\rho\sigma}(q, p, -p-q) f^{bcd} V^{\nu\rho\sigma}(-q, -p, q+p) \quad (140)$$

where the overall factor $\frac{1}{2}$ is a symmetry factor.

- With help of FeynCalc, we obtain

$$(2\pi\mu)^{4-n} \frac{1}{2} \int d^n p \frac{V^{\mu\rho\sigma}(q, p, -p-q) V^{\nu\rho\sigma}(-q, -p, q+p)}{p^2 (p+q)^2} = \frac{i\pi^2}{36} \left\{ 2q^\mu q^\nu [33B_0(q^2; 0, 0) + 1] - q^2 g^{\mu\nu} [57B_0(q^2; 0, 0) + 2] \right\} \quad (141)$$

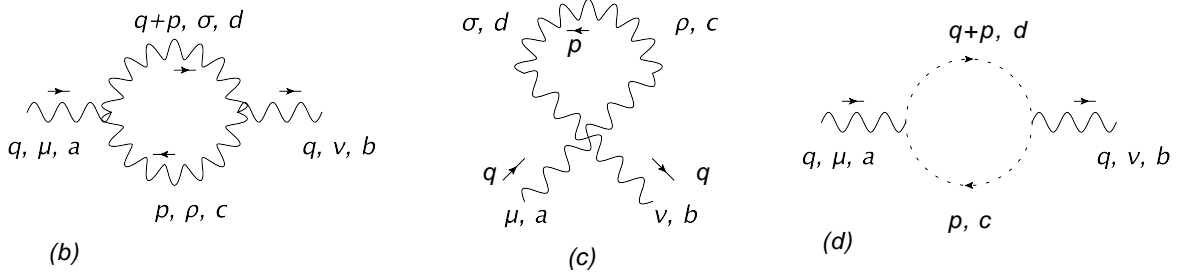

Figure 9: (b) Gluon self-energy (gluon-loop 1); (c) Gluon self-energy (gluon-loop 2); (d) Gluon self-energy (ghost-loop).

- Thus we find

$$i\Pi_{\mu\nu}^{ab(1)}(q) = iC_G\delta^{ab}\frac{g^2}{16\pi^2}\frac{1}{36} \times \left\{ q^2 g^{\mu\nu} [57B_0(q^2; 0, 0) + 2] - 2q^\mu q^\nu [33B_0(q^2; 0, 0) + 1] \right\} \quad (142)$$

where $f^{acd}f^{bcd} = C_G\delta^{ab}$ with $C_G = 3$.

3. Gluon-loop contribution 2

$$i\Pi_{\mu\nu}^{ab(1)}(q) = \frac{1}{2} \int \frac{d^n p}{(2\pi)^n} \frac{-ig^{\rho\sigma}\delta^{cd}}{p^2} (-i(g\mu^\epsilon)^2) W_{\mu\nu\rho\sigma}^{abcd} \quad (143)$$

where the overall factor $\frac{1}{2}$ is a symmetry factor.

- Since

$$g^{\rho\sigma}\delta^{cd}W_{\mu\nu\rho\sigma}^{abcd} = 2(n-1)C_G\delta^{ab}g^{\mu\nu} \int \frac{d^n p}{(2\pi)^n} \frac{1}{p^2} = 0 \quad (144)$$

- We obtain

$$i\Pi_{\mu\nu}^{ab(1)}(q) = 0 \quad (145)$$

4. Ghost-loop contribution

$$i\Pi_{\mu\nu}^{ab(1)}(q) = (-1)(g\mu^\epsilon)^2 \int \frac{d^n p}{(2\pi)^n} \frac{i}{p^2} \frac{i}{(p+q)^2} [-f^{dac}(q+p)_\mu] [-f^{cbd}p_\nu] \quad (146)$$

- FeynCalc gives

$$(2\pi\mu)^{4-n} \int d^n p \frac{(q+p)_\mu p_\nu}{p^2(p+q)^2} = \frac{-i\pi^2}{36} \left\{ q^2 g^{\mu\nu} [3B_0(q^2; 0, 0) + 2] + 2q^\mu q^\nu [3B_0(q^2; 0, 0) - 1] \right\} \quad (147)$$

- Thus we find

$$i\Pi_{\mu\nu}^{ab(1)}(q) = iC_G\delta^{ab}\frac{g^2}{16\pi^2}\frac{1}{36} \times \left\{ q^2 g^{\mu\nu} [B_0(q^2; 0, 0) + 2] + 2q^\mu q^\nu [3B_0(q^2; 0, 0) - 1] \right\} \quad (148)$$

- Note

$$i\Pi_{\mu\nu}^{ab(1)}(q) + i\Pi_{\mu\nu}^{ab(1)}(q) + i\Pi_{\mu\nu}^{ab(1)}(q) = i(q^2 g^{\mu\nu} - q^\mu q^\nu)\delta^{ab}\frac{g^2}{16\pi^2}C_G\left[\frac{5}{3}B_0(q^2; 0, 0) + \frac{1}{9}\right] \quad (149)$$

- From the expression of $B_0(q^2; 0, 0)$ given in Eq.(332), we obtain

$$Z_{3(gluon+ghost)}^{(1)} = \frac{g^2}{16\pi^2} S^\epsilon \frac{1}{\epsilon} \frac{5}{3} C_G \quad (150)$$

Adding the results of Eqs.(139) and (150), we obtain for $Z_3^{(1)}(\alpha_s)$ (in Feynman gauge $\xi = 1$)

$$Z_3^{(1)}(\alpha_s) = \frac{\alpha_s}{4\pi} S^\epsilon \frac{1}{\epsilon} \left[\frac{5}{3} C_G - \frac{4}{3} n_f T_R \right] \quad (151)$$

3.5.3 Quark Self-energy $Z_2^{(1)}(\alpha_s)$

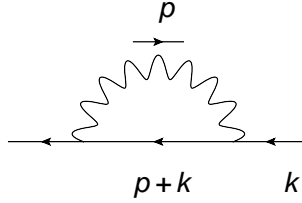

Figure 10: Quark-self energy

The quark self-energy $-i\Sigma^{(1)}(\not{k})$ in one-loop order:

$$\begin{aligned} -i\Sigma^{(1)}(\not{k}) &= (ig\mu^\epsilon)^2 [T^a T^a] \int \frac{d^n p}{(2\pi)^n} \gamma^\mu \frac{i}{\not{k} + \not{p}} \gamma_\mu \frac{-i}{p^2} \\ &= -(g\mu^\epsilon)^2 C_F \int \frac{d^n p}{(2\pi)^n} \frac{\gamma^\mu (\not{k} + \not{p}) \gamma_\mu}{(k+p)^2 p^2} \end{aligned} \quad (152)$$

where $T^a T^a = C_F \mathbf{1}$ with $C_F = \frac{4}{3}$.

- FeynCalc gives

$$(2\pi\mu)^{4-n} \int d^n p \frac{\gamma^\mu (\not{k} + \not{p}) \gamma_\mu}{(k+p)^2 p^2} = -i\pi^2 \not{k} [B_0(k^2; 0, 0) - 1] \quad (153)$$

- Thus we find

$$\Sigma^{(1)}(\not{k}) = \frac{-g^2}{16\pi^2} \not{k} [B_0(k^2; 0, 0) - 1] \quad (154)$$

- From the expression of $B_0(k^2; 0, 0)$ given in Eq.(332), we obtain

$$Z_2^{(1)}(\alpha_s) = \frac{\alpha_s}{4\pi} S^\epsilon \frac{1}{\epsilon} (-C_F) \quad (155)$$

3.5.4 Quark-gluon vertex function $Z_1^{(1)}(\alpha_s)$

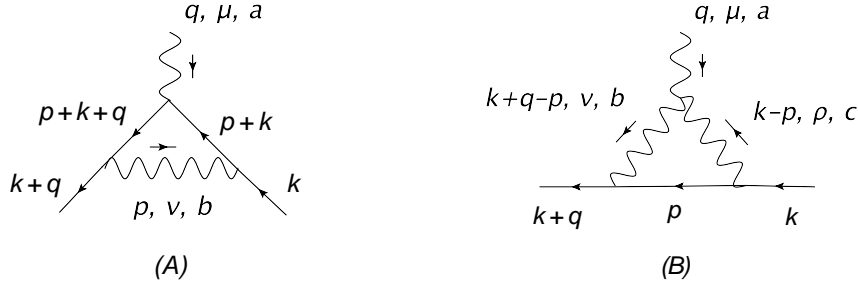

Figure 11: (A) Quark-gluon vertex, $\Gamma_{\mu(A)}^{(1)}(k', k)$; (B) Quark-gluon vertex, $\Gamma_{\mu(B)}^{(1)}(k', k)$

Two one-loop diagrams contribute to the quark-gluon vertex function $\Gamma_\mu^{(1)}(k', k)$.

1. Type A

$$\begin{aligned} ig\Gamma_{\mu(A)}^{(1)}(k', k)T^a &= ig(ig\mu^\epsilon)^2 \int \frac{d^n p}{(2\pi)^n} [\gamma^\nu T^b] \frac{i}{\not{p} + \not{k} + \not{q}} [\gamma^\mu T^a] \frac{i}{\not{p} + \not{k}} [\gamma_\nu T^b] \frac{-i}{p^2} \\ &= g(g\mu^\epsilon)^2 [T^b T^a T^b] \int \frac{d^n p}{(2\pi)^n} \frac{\gamma^\nu (\not{p} + \not{k} + \not{q}) \gamma^\mu (\not{p} + \not{k}) \gamma_\nu}{(p+k+q)^2 (p+k)^2 p^2} \end{aligned} \quad (156)$$

where $k' = k + q$.

- $T^b T^a T^b = [C_F - \frac{1}{2}C_G]T^a$
- With help of FeynCalc, we evaluate

$$S_A^\mu \equiv (2\pi\mu)^{4-n} \int d^n p \frac{\gamma^\nu (\not{p} + \not{k} + \not{q}) \gamma^\mu (\not{p} + \not{k}) \gamma_\nu}{(p+k+q)^2 (p+k)^2 p^2} \quad (157)$$

with a constraint $(k+q)^2 = k^2$. Then, we find that S_A^μ is expressed in terms of $B_0(q^2; 0, 0)$, $B_0(k^2; 0, 0)$ and $C_0(k^2, q^2, k^2; 0, 0, 0)$. The ultraviolet divergence appears in $B_0(q^2; 0, 0)$ and $B_0(k^2; 0, 0)$.

The sum of the coefficients of $B_0(q^2; 0, 0)$ and $B_0(k^2; 0, 0)$ turns out to be expressed as $i\pi^2 \gamma^\mu$

- The divergent part of $\Gamma_{\mu(A)}^{(1)}(k', k)T^a$ is

$$\Gamma_{\mu(A)}^{(1)}(k', k)T^a \sim \frac{g^2}{16\pi^2} S^\epsilon \frac{1}{\epsilon} [C_F - \frac{1}{2}C_G]T^a \quad (158)$$

2. Type B

$$\begin{aligned} ig\Gamma_{\mu(B)}^{(1)}(k', k)T^a &= (ig\mu^\epsilon)^2 \int \frac{d^n p}{(2\pi)^n} [\gamma^\nu T^b] \frac{i\not{p}}{p^2} [\gamma^\rho T^c] g f^{abc} V^{\mu\nu\rho}(q, p-k-q, k-p) \\ &\times \frac{-i}{(k+q-p)^2} \frac{-i}{(k-p)^2} \end{aligned} \quad (159)$$

where $k' = k + q$.

- $T^b T^c f^{abc} = \frac{1}{2}iC_G T^a$
- With help of FeynCalc, we evaluate

$$S_B^\mu \equiv (2\pi\mu)^{4-n} \int d^n p \frac{\gamma^\nu \not{p} \gamma^\rho V^{\mu\nu\rho}(q, p-k-q, k-p)}{p^2(k+q-p)^2(k-p)^2} \quad (160)$$

with a constraint $(k+q)^2 = k^2$. Then, we find that S_B^μ is expressed in terms of $B_0(q^2; 0, 0)$, $B_0(k^2; 0, 0)$ and $C_0(k^2, q^2, k^2; 0, 0, 0)$. The ultraviolet divergence appears in $B_0(q^2; 0, 0)$ and $B_0(k^2; 0, 0)$.

The sum of the coefficients of $B_0(q^2; 0, 0)$ and $B_0(k^2; 0, 0)$ turns out to be expressed as $-3i\pi^2\gamma^\mu$

- The divergent part of $\Gamma_{\mu(B)}^{(1)}(k', k)T^a$ is

$$\Gamma_{\mu(B)}^{(1)}(k', k)T^a \sim \frac{g^2}{16\pi^2} S^\epsilon \frac{1}{\epsilon} \frac{3}{2}C_G T^a \quad (161)$$

◇ Adding the results of Eqs.(158) and (161), we obtain for the divergent part of $\Gamma_\mu^{(1)}(k', k)$ (in Feynman gauge $\xi = 1$)

$$\Gamma_\mu^{(1)}(k', k) = \frac{\alpha_s}{4\pi} S^\epsilon \frac{1}{\epsilon} [C_F + C_G] \quad (162)$$

◇ Thus we obtain for $Z_1^{(1)}(\alpha_s)$ (in Feynman gauge $\xi = 1$)

$$Z_1^{(1)}(\alpha_s) = -\frac{\alpha_s}{4\pi} S^\epsilon \frac{1}{\epsilon} [C_F + C_G] \quad (163)$$

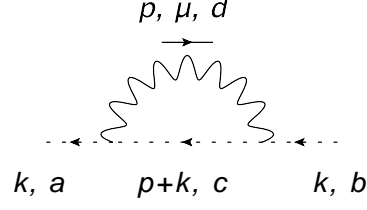

Figure 12: Ghost self-energy

3.5.5 Ghost Self-energy $\tilde{Z}_2^{(1)}(\alpha_s)$

The ghost self-energy $-i\Sigma_{FP}^{(1)}(k)$ in one-loop order:

$$-i\Sigma_{FP}^{ab(1)}(k) = (g\mu^\epsilon)^2 \int \frac{d^n p}{(2\pi)^n} [-f^{adc}k^\mu][f^{cdb}(p+k)_\mu] \frac{-i}{p^2} \frac{i}{(p+k)^2} \quad (164)$$

- $f^{adc}f^{cdb} = -C_G\delta^{ab}$
- FeynCalc gives

$$(2\pi\mu)^{4-n} \int d^n p \frac{k \cdot (p+k)}{p^2(p+k)^2} = \frac{i\pi^2}{2} k^2 B_0(k^2; 0, 0) \quad (165)$$

- Thus we find

$$\Sigma_{FP}^{ab(1)}(k) = \frac{g^2}{16\pi^2} \frac{1}{2} C_G \delta^{ab} k^2 B_0(k^2; 0, 0) \quad (166)$$

- Thus we obtain

$$\tilde{Z}_2^{(1)}(\alpha_s) = \frac{\alpha_s}{4\pi} S^\epsilon \frac{1}{\epsilon} \frac{1}{2} C_G \quad (167)$$

3.5.6 Ghost-gluon vertex function $Z_1^{FP(1)}(\alpha_s)$

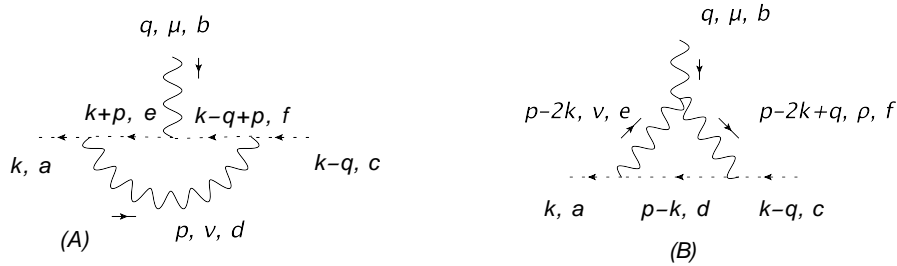

Figure 13: (A) Ghost-gluon vertex, $\Gamma_{\mu(A)}^{FP(1)}(k', k)$; (B) Ghost-gluon vertex, $\Gamma_{\mu(B)}^{FP(1)}(k', k)$

Two one-loop diagrams contribute to the ghost-gluon vertex function $\Gamma_{\mu}^{abcFP(1)}(k, q)$.

1. Type A

$$g\Gamma_{\mu(A)}^{abcFP(1)}(k, q) = g(g\mu^\epsilon)^2 \int \frac{d^n p}{(2\pi)^n} [-f^{ade}k^\nu][-f^{ebf}(k+p)^\mu][-f^{fdc}(k-q+p)^\nu] \\ \times \frac{-i}{p^2} \frac{i}{(k+p)^2} \frac{i}{(k-q+p)^2} \quad (168)$$

- $f^{ade}f^{ebf}f^{fdc} = -\frac{1}{2}C_G f^{abc}$
- With help of FeynCalc, we evaluate

$$F_{FP(A)}^\mu \equiv (2\pi\mu)^{4-n} \int d^n p \frac{k^\nu(k+p)^\mu(k-q+p)_\nu}{p^2(k+p)^2(k-q+p)^2} \quad (169)$$

Then, we find that $F_{FP(B)}^\mu$ is expressed in terms of $B_0(q^2; 0, 0)$, $B_0(k^2; 0, 0)$, $B_0((k-q)^2; 0, 0)$ and $C_0(k^2, q^2, (k-q)^2; 0, 0, 0)$. The ultraviolet divergence appears in $B_0(q^2; 0, 0)$, $B_0(k^2; 0, 0)$ and $B_0((k-q)^2; 0, 0)$.

The sum of the coefficients of $B_0(q^2; 0, 0)$, $B_0(k^2; 0, 0)$ and $B_0((k-q)^2; 0, 0)$ turns out to be expressed as $\frac{1}{4}i\pi^2 k^\mu$

- The divergent part of $g\Gamma_{\mu(A)}^{abcFP(1)}(k, q)$ is

$$g\Gamma_{\mu(A)}^{abcFP(1)}(k, q) \sim [-gf^{abc}k^\mu] \frac{g^2}{16\pi^2} S^\epsilon \frac{1}{\epsilon} \left(\frac{1}{8}C_G \right) \quad (170)$$

- Thus we obtain

$$Z_{1(A)}^{FP(1)}(\alpha_s) = \frac{\alpha_s}{4\pi} S^\epsilon \frac{1}{\epsilon} \left(-\frac{1}{8}C_G \right) \quad (171)$$

2. Type B

$$g\Gamma_{\mu(B)}^{abcFP(1)}(k, q) = g(g\mu^\epsilon)^2 \int \frac{d^n p}{(2\pi)^n} [-f^{aed}k^\nu][-f^{dfc}(p-k)^\rho] \\ \times f^{bef}V_{\mu\nu\rho}(q, p-2k, -p+2k-q) \frac{-i}{(p-2k)^2} \frac{-i}{(p-2k+q)^2} \frac{i}{(p-k)^2} \quad (172)$$

- $f^{aed}f^{dfc}f^{bef} = \frac{1}{2}C_G f^{abc}$
- With help of FeynCalc, we evaluate

$$F_{FP(B)}^\mu \equiv (2\pi\mu)^{4-n} \int d^n p \frac{k^\nu(p-k)^\rho V_{\mu\nu\rho}(q, p-2k, -p+2k-q)}{(p-2k)^2(p-2k+q)^2(p-k)^2} \quad (173)$$

Then, we find that $F_{FP(B)}^\mu$ is expressed in terms of $B_0(q^2; 0, 0)$, $B_0(k^2; 0, 0)$, $B_0((k-q)^2; 0, 0)$ and $C_0(k^2, q^2, (k-q)^2; 0, 0, 0)$. The ultraviolet divergence appears in $B_0(q^2; 0, 0)$, $B_0(k^2; 0, 0)$ and $B_0((k-q)^2; 0, 0)$.

The sum of the coefficients of $B_0(q^2; 0, 0)$, $B_0(k^2; 0, 0)$ and $B_0((k-q)^2; 0, 0)$ turns out to be expressed as $-\frac{3}{4}i\pi^2 k^\mu$

- The divergent part of $g\Gamma_{\mu(B)}^{abcFP(1)}(k, q)$ is

$$g\Gamma_{\mu(B)}^{abcFP(1)}(k, q) \sim [-gf^{abc}k^\mu] \frac{g^2}{16\pi^2} S^\epsilon \frac{1}{\epsilon} \left(\frac{3}{8} C_G \right) \quad (174)$$

◇ The sum

$$g\Gamma_{\mu(A)}^{abcFP(1)}(k, q) + g\Gamma_{\mu(B)}^{abcFP(1)}(k, q) \sim [-gf^{abc}k^\mu] \frac{g^2}{16\pi^2} S^\epsilon \frac{1}{\epsilon} \left(\frac{1}{2} C_G \right) \quad (175)$$

◇ Thus we obtain

$$Z_1^{FP(1)}(\alpha_s) = \frac{\alpha_s}{4\pi} S^\epsilon \frac{1}{\epsilon} \left(-\frac{1}{2} C_G \right) \quad (176)$$

3.5.7 Three-gluon vertex function $Z_1^{3g(1)}(\alpha_s)$

Four types of one-loop diagrams contribute to the three-gluon vertex function $\Lambda_{\mu\nu\rho}^{abc}(k, p, q)$.

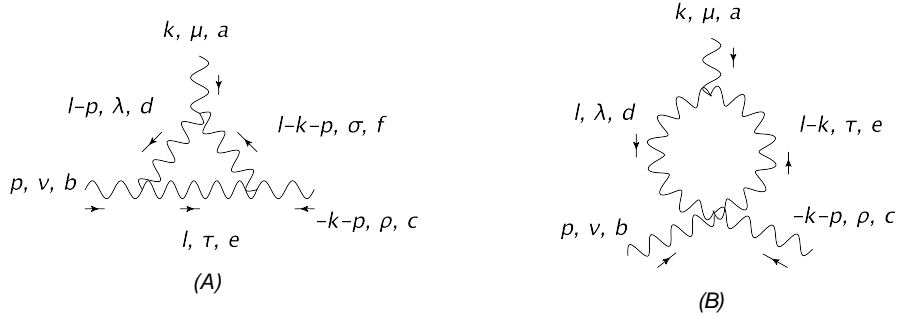

Figure 14: Three-gluon vertices: (A) $g\Lambda_{\mu\nu\rho}^{abcA}(k, p, q)$ and (B) $g\Lambda_{\mu\nu\rho}^{abcB(a)}(k, p, q)$.

1. Type A $[\Lambda_{\mu\nu\rho}^{abcA}(k, p, q)]$ (gluon contribution 1)

$$\begin{aligned} g\Lambda_{\mu\nu\rho}^{abcA}(k, p, q) &= g(g\mu^\epsilon)^2 \int \frac{d^n l}{(2\pi)^n} [f^{adf} V^{\mu\lambda\sigma}(k, p-l, l-k-p)] \\ &\times [f^{bed} V^{\nu\tau\lambda}(p, -l, l-p)] [f^{cfe} V^{\rho\sigma\tau}(-k-p, -l+k+p, l)] \frac{-i}{l^2} \frac{-i}{(l-k-p)^2} \frac{-i}{(l-p)^2} \end{aligned} \quad (177)$$

with $q = -k - p$.

- $f^{adf} f^{bed} f^{cfe} = -\frac{1}{2} C_G f^{abc}$ (from Eq.(353))
- With help of FeynCalc, we evaluate

$$\begin{aligned} \tilde{\Lambda}_{\mu\nu\rho}^A &\equiv (2\pi\mu)^{4-n} \int d^n l \frac{N_{\mu\nu\rho}^A}{l^2 (l-k-p)^2 (l-p)^2} \\ \text{where } N_{\mu\nu\rho}^A &= V^{\mu\lambda\sigma}(k, p-l, l-k-p) V^{\nu\tau\lambda}(p, -l, l-p) \\ &\times V^{\rho\sigma\tau}(-k-p, -l+k+p, l) \end{aligned} \quad (178)$$

at the symmetric point $k^2 = p^2 = q^2 = -M^2$. Then, we find that $\tilde{\Lambda}_{\mu\nu\rho}^A$ is expressed in terms of $B_0(-M^2; 0, 0)$ and $C_0(-M^2, -M^2, -M^2; 0, 0, 0)$. The ultraviolet divergence appears in $B_0(-M^2; 0, 0)$. The coefficient of $B_0(-M^2; 0, 0)$ is expressed as

$$\frac{13}{4}i\pi^2 (k^\mu g^{\nu\rho} - 2k^\nu g^{\mu\rho} + k^\rho g^{\mu\nu} + 2p^\mu g^{\nu\rho} - p^\nu g^{\mu\rho} - p^\rho g^{\mu\nu})$$

which is rewritten as (with $k + p = -q$)

$$\frac{13}{4}i\pi^2 \{g^{\mu\nu}(k-p)^\rho + g^{\nu\rho}(p-q)^\mu + g^{\rho\mu}(q-k)^\nu\} = \frac{13}{4}i\pi^2 V^{\mu\nu\rho}(k, p, q) \quad (179)$$

- The divergent part of $g\Lambda_{\mu\nu\rho}^{abcA}(k, p, q)$ is

$$g\Lambda_{\mu\nu\rho}^{abcA}(k, p, q) \sim g f^{abc} V^{\mu\nu\rho}(k, p, q) \times \frac{g^2}{16\pi^2} S^\epsilon \frac{1}{\epsilon} \left[\frac{13}{8} C_G \right] \quad (180)$$

2. Type B $[\Lambda_{\mu\nu\rho}^{abcB}(k, p, q)]$ (gluon contribution 2)

$$\begin{aligned} g\Lambda_{\mu\nu\rho}^{abcB(a)}(k, p, q) &= \frac{1}{2}g(g\mu^\epsilon)^2 \int \frac{d^n l}{(2\pi)^n} [f^{ade} V^{\mu\lambda\tau}(k, -l, l-k)] \\ &\quad \times [-iW_{\lambda\tau\nu\rho}^{debc}] \frac{-i}{l^2} \frac{-i}{(l-k)^2} \end{aligned} \quad (181)$$

where $\frac{1}{2}$ is symmetry factor.

- $f^{ade} V^{\mu\lambda\tau}(k, -l, l-k)[-iW_{\lambda\tau\nu\rho}^{debc}] = \frac{9}{2}iC_G f_{abc} (k^\nu g^{\mu\rho} - k^\rho g^{\mu\nu})$
- With help of FeynCalc, we evaluate

$$\begin{aligned} \tilde{\Lambda}_{\mu\nu\rho}^{B(a)} &\equiv (2\pi\mu)^{4-n} \int d^n l \frac{(k^\nu g^{\mu\rho} - k^\rho g^{\mu\nu})}{l^2(l-k)^2} = i\pi^2 (k^\nu g^{\mu\rho} - k^\rho g^{\mu\nu}) B_0(k^2, 0, 0) \\ &\sim i\pi^2 (k^\nu g^{\mu\rho} - k^\rho g^{\mu\nu}) S^\epsilon \frac{1}{\epsilon} \end{aligned} \quad (182)$$

- Thus we find the divergent part of $g\Lambda_{\mu\nu\rho}^{abcB(a)}(k, p, q)$ as

$$g\Lambda_{\mu\nu\rho}^{abcB(a)}(k, p, q) \sim \frac{g^3}{16\pi^2} S^\epsilon \frac{1}{\epsilon} \left(\frac{9}{4} C_G \right) f^{abc} (k^\nu g^{\mu\rho} - k^\rho g^{\mu\nu}) \quad (183)$$

The other two diagrams which are obtained from Fig.14.(B) by cyclic permutations also contribute. Adding the factors from these terms, we obtain

$$\begin{aligned} &f^{abc} (k^\nu g^{\mu\rho} - k^\rho g^{\mu\nu}) + f^{bca} (p^\rho g^{\nu\mu} - p^\mu g^{\nu\rho}) + f^{cab} (q^\mu g^{\rho\nu} - q^\nu g^{\rho\mu}) \\ &= -f^{abc} V^{\mu\nu\rho}(k, p, q) \end{aligned} \quad (184)$$

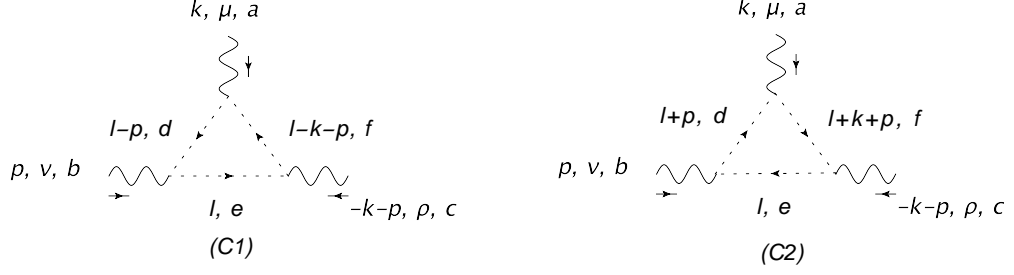

Figure 15: Three-gluon vertices: (C1) $g\Lambda_{\mu\nu\rho}^{abc(C1)}(k, p, q)$ and (C2) $g\Lambda_{\mu\nu\rho}^{abc(C2)}(k, p, q)$.

Finally we obtain for the divergent part of $g\Lambda_{\mu\nu\rho}^{abcB}(k, p, q)$ as

$$\begin{aligned}
g\Lambda_{\mu\nu\rho}^{abcB}(k, p, q) &= g\Lambda_{\mu\nu\rho}^{abcB(a)}(k, p, q) + g\Lambda_{\mu\nu\rho}^{abcB(b)}(k, p, q) + g\Lambda_{\mu\nu\rho}^{abcB(c)}(k, p, q) \\
&\sim g f^{abc} V^{\mu\nu\rho}(k, p, q) \times \frac{g^2}{16\pi^2} S^\epsilon \frac{1}{\epsilon} \left[-\frac{9}{4} C_G \right] \quad (185)
\end{aligned}$$

3. Type C $[\Lambda_{\mu\nu\rho}^{abcC}(k, p, q)]$ (ghost-loop contribution)

Two diagrams contribute. See Fig.15 (C1) and (C2).

◇ The first one is, with $q = -k - p$,

$$\begin{aligned}
g\Lambda_{\mu\nu\rho}^{abcC(1)}(k, p, q) &= (-1)g(g\mu^\epsilon)^2 \int \frac{d^n l}{(2\pi)^n} [-f^{daf}(l-p)_\mu] [-f^{ebd}l_\nu] [-f^{fce}(l-k-p)_\rho] \\
&\quad \times \frac{i}{(l-p)^2} \frac{i}{l^2} \frac{i}{(l-k-p)^2} \quad (186)
\end{aligned}$$

- $f^{daf} f^{ebd} f^{fce} = \frac{1}{2} C_G f^{abc}$ (from Eq.(353))
- With help of FeynCalc, we evaluate

$$\tilde{\Lambda}_{\mu\nu\rho}^{C(1)} \equiv (2\pi\mu)^{4-n} \int d^n l \frac{(l-p)_\mu l_\nu (l-k-p)_\rho}{(l-p)^2 l^2 (l-k-p)^2} \quad (187)$$

at the symmetric point $k^2 = p^2 = q^2 = -M^2$. Then, we find that $\tilde{\Lambda}_{\mu\nu\rho}^{C(1)}$ is expressed in terms of $B_0(-M^2; 0, 0)$ and $C_0(-M^2, -M^2, -M^2; 0, 0, 0)$. The ultraviolet divergence appears in $B_0(-M^2; 0, 0)$. The coefficient of $B_0(-M^2; 0, 0)$ is expressed as

$$\frac{i\pi^2}{12} (k^\mu g^{\nu\rho} + k^\nu g^{\mu\rho} - 2k^\rho g^{\mu\nu} - p^\mu g^{\nu\rho} + 2p^\nu g^{\mu\rho} - p^\rho g^{\mu\nu})$$

which is rewritten as (with $k + p = -q$)

$$\frac{i\pi^2}{12} \{ g^{\mu\nu} (q-k)^\rho + g^{\nu\rho} (k-p)^\mu + g^{\rho\mu} (p-q)^\nu \} \quad (188)$$

- The divergent part of $g\Lambda_{\mu\nu\rho}^{abcC(1)}(k, p, q)$ is

$$g\Lambda_{\mu\nu\rho}^{abcC(1)}(k, p, q) \sim \frac{g^3}{16\pi^2} S^\epsilon \frac{1}{\epsilon} \left[\frac{1}{24} C_G f^{abc} \right] \\ \times \left\{ g^{\mu\nu} (q - k)^\rho + g^{\nu\rho} (k - p)^\mu + g^{\rho\mu} (p - q)^\nu \right\} \quad (189)$$

◇ The second one is, with $q = -k - p$,

$$g\Lambda_{\mu\nu\rho}^{abcC(2)}(k, p, q) = (-1)g(g\mu^\epsilon)^2 \int \frac{d^n l}{(2\pi)^n} [-f^{fad}(l + k + p)_\mu] [-f^{dbe}(l + p)_\nu] [-f^{ecf}l_\rho] \\ \times \frac{i}{(l + p)^2} \frac{i}{l^2} \frac{i}{(l + k + p)^2} \quad (190)$$

- $f^{fad} f^{dbe} f^{ecf} = -\frac{1}{2} C_G f^{abc}$ (from Eq.(353))
- With help of FeynCalc, we evaluate

$$\tilde{\Lambda}_{\mu\nu\rho}^{C(2)} \equiv (2\pi\mu)^{4-n} \int d^n l \frac{(l + k + p)_\mu (l + p)_\nu l_\rho}{(l + p)^2 l^2 (l + k + p)^2} \quad (191)$$

at the symmetric point $k^2 = p^2 = q^2 = -M^2$. Then, we find that $\tilde{\Lambda}_{\mu\nu\rho}^{C(2)}$ is expressed in terms of $B_0(-M^2; 0, 0)$ and $C_0(-M^2, -M^2, -M^2; 0, 0, 0)$. The ultraviolet divergence appears in $B_0(-M^2; 0, 0)$. The coefficient of $B_0(-M^2; 0, 0)$ is expressed as

$$\frac{i\pi^2}{12} (2k^\mu g^{\nu\rho} - k^\nu g^{\mu\rho} - k^\rho g^{\mu\nu} + p^\mu g^{\nu\rho} + p^\nu g^{\mu\rho} - 2p^\rho g^{\mu\nu})$$

which is rewritten as (with $k + p = -q$)

$$\frac{i\pi^2}{12} \left\{ g^{\mu\nu} (q - p)^\rho + g^{\nu\rho} (k - q)^\mu + g^{\rho\mu} (p - k)^\nu \right\} \quad (192)$$

- The divergent part of $g\Lambda_{\mu\nu\rho}^{abcC(2)}(k, p, q)$ is

$$g\Lambda_{\mu\nu\rho}^{abcC(2)}(k, p, q) \sim \frac{g^3}{16\pi^2} S^\epsilon \frac{1}{\epsilon} \left[-\frac{1}{24} C_G f^{abc} \right] \\ \times \left\{ g^{\mu\nu} (q - p)^\rho + g^{\nu\rho} (k - q)^\mu + g^{\rho\mu} (p - k)^\nu \right\} \quad (193)$$

◇ The sum of $g\Lambda_{\mu\nu\rho}^{abcC(1)}(k, p, q)$ and $g\Lambda_{\mu\nu\rho}^{abcC(2)}(k, p, q)$:

- Since

$$\left\{ g^{\mu\nu} (q - k)^\rho + g^{\nu\rho} (k - p)^\mu + g^{\rho\mu} (p - q)^\nu \right\} - \left\{ g^{\mu\nu} (q - p)^\rho + g^{\nu\rho} (k - q)^\mu + g^{\rho\mu} (p - k)^\nu \right\} \\ = \left\{ g^{\mu\nu} (p - k)^\rho + g^{\nu\rho} (q - p)^\mu + g^{\rho\mu} (k - q)^\nu \right\} \\ = -V^{\mu\nu\rho}(k, p, q) \quad (194)$$

- Thus we obtain

$$\begin{aligned}
g\Lambda_{\mu\nu\rho}^{abcC}(k, p, q) &= g\Lambda_{\mu\nu\rho}^{abcC(1)}(k, p, q) + g\Lambda_{\mu\nu\rho}^{abcC(2)}(k, p, q) \\
&\sim gf^{abc}V^{\mu\nu\rho}(k, p, q) \times \frac{g^2}{16\pi^2} S^\epsilon \frac{1}{\epsilon} \left[-\frac{1}{24}C_G\right] \quad (195)
\end{aligned}$$

4. Type D $[\Lambda_{\mu\nu\rho}^{abcD}(k, p, q)]$ (quark-loop contribution)

Two diagrams contribute. See Fig.22 (D1) and (D2)

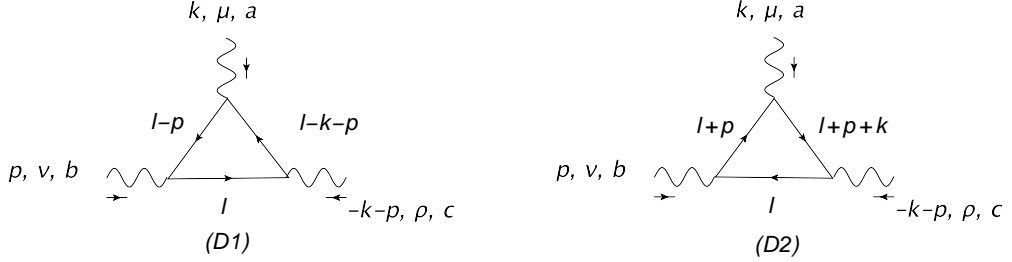

Figure 16: Three-gluon vertices: (D1) $\Lambda_{\mu\nu\rho}^{abcD(1)}(k, p, q)$ and (D2) $\Lambda_{\mu\nu\rho}^{abcD(2)}(k, p, q)$.

◇ The first one is

$$g\Lambda_{\mu\nu\rho}^{abcD(1)}(k, p, q) = (-1)g(g\mu^\epsilon)^2 \int \frac{d^n l}{(2\pi)^n} \text{Tr}[(i\gamma^\mu T^a) \frac{i}{\not{l} - \not{k} - \not{p}} (i\gamma^\rho T^c) \frac{i}{\not{l}} (i\gamma^\nu T^b) \frac{i}{\not{l} - \not{p}}] \quad (196)$$

with $q = -k - p$.

- With help of FeynCalc, we evaluate

$$\tilde{\Lambda}_{\mu\nu\rho}^{D(1)} \equiv (2\pi\mu)^{4-n} \int d^n l \frac{\text{Tr}[\gamma^\mu (\not{l} - \not{k} - \not{p}) \gamma^\rho \not{l} \gamma^\nu (\not{l} - \not{p})]}{(l-k-p)^2 l^2 (l-p)^2} \quad (197)$$

at the symmetric point $k^2 = p^2 = q^2 = -M^2$. Then, we find that $\tilde{\Lambda}_{\mu\nu\rho}^{D(1)}$ is expressed in terms of $B_0(-M^2; 0, 0)$ and $C_0(-M^2, -M^2, -M^2; 0, 0, 0)$. The ultraviolet divergence appears in $B_0(-M^2; 0, 0)$. The coefficient of $B_0(-M^2; 0, 0)$ is expressed as

$$\frac{4}{3}i\pi^2 (k^\mu g^{\nu\rho} - 2k^\nu g^{\mu\rho} + k^\rho g^{\mu\nu} + 2p^\mu g^{\nu\rho} - p^\nu g^{\mu\rho} - p^\rho g^{\mu\nu})$$

which is rewritten as (with $k + p = -q$)

$$\frac{4}{3}i\pi^2 \{g^{\mu\nu}(k-p)^\rho + g^{\nu\rho}(p-q)^\mu + g^{\rho\mu}(q-k)^\nu\} = \frac{4}{3}i\pi^2 V^{\mu\nu\rho}(k, p, q) \quad (198)$$

- The divergent part of $g\Lambda_{\mu\nu\rho}^{abcD(1)}(k, p, q)$ is

$$g\Lambda_{\mu\nu\rho}^{abcD(1)}(k, p, q) \sim gV^{\mu\nu\rho}(k, p, q) \times \frac{g^2}{16\pi^2} S^\epsilon \frac{1}{\epsilon} \left\{ \frac{4i}{3} \text{tr}[T^a T^c T^b] \right\} \quad (199)$$

◇ The second one is

$$g\Lambda_{\mu\nu\rho}^{abcD(2)}(k, p, q) = (-1)g(g\mu^\epsilon)^2 \int \frac{d^n l}{(2\pi)^n} \text{Tr} \left[(i\gamma^\mu T^a) \frac{i}{\not{l} + \not{p}} (i\gamma^\nu T^b) \frac{i}{\not{l}} (i\gamma^\rho T^c) \frac{i}{\not{l} + \not{p} + \not{k}} \right] \quad (200)$$

with $q = -k - p$.

- With help of FeynCalc, we evaluate

$$\tilde{\Lambda}_{\mu\nu\rho}^{D(2)} \equiv (2\pi\mu)^{4-n} \int d^n l \frac{\text{Tr}[\gamma^\mu(\not{l} + \not{p})\gamma^\nu \not{l} \gamma^\rho(\not{l} + \not{p} + \not{k})]}{(l+p)^2 l^2 (l+p+k)^2} \quad (201)$$

at the symmetric point $k^2 = p^2 = q^2 = -M^2$. Then, we find that $\tilde{\Lambda}_{\mu\nu\rho}^{D(2)}$ is expressed in terms of $B_0(-M^2; 0, 0)$ and $C_0(-M^2, -M^2, -M^2; 0, 0, 0)$. The ultraviolet divergence appears in $B_0(-M^2; 0, 0)$. The coefficient of $B_0(-M^2; 0, 0)$ is expressed as

$$-\frac{4}{3}i\pi^2 (k^\mu g^{\nu\rho} - 2k^\nu g^{\mu\rho} + k^\rho g^{\mu\nu} + 2p^\mu g^{\nu\rho} - p^\nu g^{\mu\rho} - p^\rho g^{\mu\nu})$$

which is rewritten as (with $k + p = -q$)

$$-\frac{4}{3}i\pi^2 \left\{ g^{\mu\nu}(k-p)^\rho + g^{\nu\rho}(p-q)^\mu + g^{\rho\mu}(q-k)^\nu \right\} = -\frac{4}{3}i\pi^2 V^{\mu\nu\rho}(k, p, q) \quad (202)$$

- The divergent part of $g\Lambda_{\mu\nu\rho}^{abcD(2)}(k, p, q)$ is

$$g\Lambda_{\mu\nu\rho}^{abcD(2)}(k, p, q) \sim gV^{\mu\nu\rho}(k, p, q) \times \frac{g^2}{16\pi^2} S^\epsilon \frac{1}{\epsilon} \left\{ -\frac{4i}{3} \text{Tr}[T^a T^b T^c] \right\} \quad (203)$$

◇ Since $\text{tr}[T^a T^b T^c] - \text{tr}[T^a T^c T^b] = if^{abc}T_R$ with $T_R = \frac{1}{2}$.

Summing over all active quark flavors, which gives the number n_f , we finally obtain for the divergent part of $\Lambda_{\mu\nu\rho}^{abcD}(k, p, q)$ as

$$\begin{aligned} g\Lambda_{\mu\nu\rho}^{abcD}(k, p, q) &= \sum_{quark} g\Lambda_{\mu\nu\rho}^{abcD(1)}(k, p, q) + \sum_{quark} g\Lambda_{\mu\nu\rho}^{abcD(2)}(k, p, q) \\ &\sim g f^{abc} V^{\mu\nu\rho}(k, p, q) \times \frac{g^2}{16\pi^2} S^\epsilon \frac{1}{\epsilon} \frac{4}{3} n_f T_R \end{aligned} \quad (204)$$

5. Summary of $\Lambda_{\mu\nu\rho}^{abc}(k, p, q)$

Adding four types of contributions to $\Lambda_{\mu\nu\rho}^{abc}(k, p, q)$, we have

$$\begin{aligned}
\Lambda_{\mu\nu\rho}^{abc}(k, p, q) &= \Lambda_{\mu\nu\rho}^{abcA}(k, p, q) + \Lambda_{\mu\nu\rho}^{abcB}(k, p, q) + \Lambda_{\mu\nu\rho}^{abcC}(k, p, q) + \Lambda_{\mu\nu\rho}^{abcD}(k, p, q) \\
&\sim f^{abc}V^{\mu\nu\rho}(k, p, q) \times \frac{g^2}{16\pi^2} S^\epsilon \frac{1}{\epsilon} \\
&\quad \times \left\{ \frac{13}{8}C_G - \frac{9}{4}C_G - \frac{1}{24}C_G + \frac{4}{3}n_f T_R \right\} \\
&= f^{abc}V^{\mu\nu\rho}(k, p, q) \times \frac{g^2}{16\pi^2} S^\epsilon \frac{1}{\epsilon} \left(-\frac{2}{3}C_G + \frac{4}{3}n_f T_R \right) \tag{205}
\end{aligned}$$

Therefore, we obtain

$$Z_1^{3g(1)}(\alpha_s) = \frac{\alpha_s}{4\pi} S^\epsilon \frac{1}{\epsilon} \left(\frac{2}{3}C_G - \frac{4}{3}n_f T_R \right) \tag{206}$$

3.5.8 Four-gluon vertex function $Z_1^{4g(1)}(\alpha_s)$

Five types of one-loop diagrams contribute to the four-gluon vertex function $\Theta_{\mu\nu\rho\sigma}^{abcd}$.

We evaluate $\Theta_{\mu\nu\rho\sigma}^{abcd}$ for all the external gluon momenta being zero, since the tree four-gluon vertex $-ig^2W_{\mu\nu\rho\tau}^{abcd}$ given in (124) does not depend on the external momenta.

1. Type A $[\Theta_{\mu\nu\rho\sigma}^{abcdA}]$ (gluon loop contribution A)

Six diagrams contribute. See Fig.17.

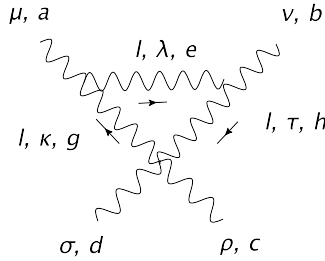

Figure 17: Four-gluon vertex (gluon-loop contribution): $\Theta_{(\mu\nu)\rho\sigma}^{(ab)cdA}$

◇ The first one (with a gluon propagator between the external gluon lines (μ, a) and (ν, b)) is

$$\begin{aligned}
-ig^2\Theta_{(\mu\nu)\rho\sigma}^{(ab)cdA} &= g^2(g\mu^\epsilon)^2 \int \frac{d^n l}{(2\pi)^n} [f^{gae}V^{\kappa\mu\lambda}(l, 0, -l)] [f^{ebh}V^{\lambda\nu\tau}(l, 0, -l)] \\
&\quad \times [-iW_{\kappa\tau\rho\sigma}^{ghcd}] \left(\frac{-i}{l^2 - \lambda^2} \right)^3 \tag{207}
\end{aligned}$$

where we have included a small mass λ in the gluon-propagators. The UV divergence does not depend on λ in $\overline{\text{MS}}$ renormalization scheme.

- With help of FeynCalc, we evaluate

$$\tilde{\Theta}_{(\mu\nu)\rho\sigma}^{(ab)cdA} \equiv (2\pi\mu)^{4-n} \int d^n l \frac{N_{(\mu\nu)\rho\sigma}^{(ab)cdA}}{(l^2 - \lambda^2)^3} \quad (208)$$

$$\text{where } N_{(\mu\nu)\rho\sigma}^{(ab)cdA} = [f^{gae} V^{\kappa\mu\lambda}(l, 0, -l)] [f^{ebh} V^{\lambda\nu\tau}(l, 0, -l)] [-iW_{\kappa\tau\rho\sigma}^{ghcd}]$$

Then, we find that $\tilde{\Theta}_{(\mu\nu)\rho\sigma}^{(ab)cdA}$ is expressed in terms of $B_0(0; \lambda^2, \lambda^2)$ and $C_0(0, 0, 0; \lambda^2, \lambda^2, \lambda^2)$. The ultraviolet divergence appears in $B_0(0; \lambda^2, \lambda^2)$. The coefficient of $B_0(0; \lambda^2, \lambda^2)$ is expressed as

$$\begin{aligned} [\text{Coef}]_{(\mu\nu)\rho\sigma}^{(ab)cd} &= -\frac{1}{4}\pi^2 f_{aeg} f_{beh} \left\{ 13g^{\mu\nu} g^{\rho\sigma} (f_{chj} f_{dgj} + f_{cgj} f_{dhj}) \right. \\ &\quad + 2g^{\mu\sigma} g^{\nu\rho} (2f_{chj} f_{dgj} - f_{cgj} f_{dhj} - 3f_{cdj} f_{ghj}) \\ &\quad \left. + 2g^{\mu\rho} g^{\nu\sigma} (-f_{chj} f_{dgj} + 2f_{cgj} f_{dhj} + 3f_{cdj} f_{ghj}) \right\} \\ &= -\frac{1}{4}\pi^2 \left\{ 13g^{\mu\nu} g^{\rho\sigma} (\hat{f}^a \hat{f}^d \hat{f}^c \hat{f}^b + \hat{f}^a \hat{f}^c \hat{f}^d \hat{f}^b) \right. \\ &\quad + 2g^{\mu\sigma} g^{\nu\rho} (2\hat{f}^a \hat{f}^d \hat{f}^c \hat{f}^b - \hat{f}^a \hat{f}^c \hat{f}^d \hat{f}^b + 3f_{cdj} (\hat{f}^a \hat{f}^j \hat{f}^b)) \\ &\quad \left. + 2g^{\mu\rho} g^{\nu\sigma} (-\hat{f}^a \hat{f}^d \hat{f}^c \hat{f}^b + 2\hat{f}^a \hat{f}^c \hat{f}^d \hat{f}^b - 3f_{cdj} (\hat{f}^a \hat{f}^j \hat{f}^b)) \right\} \quad (209) \end{aligned}$$

where $\hat{f}^a \hat{f}^d \hat{f}^c \hat{f}^b \equiv f_{aeg} f_{dgh} f_{chi} f_{bie} = \hat{f}^b \hat{f}^a \hat{f}^d \hat{f}^c$, etc. (see Eq.(349)).

- Using the following formulae (see Appendix C)

$$\hat{f}^a \hat{f}^b \hat{f}^c \hat{f}^d = \hat{f}^d \hat{f}^a \hat{f}^b \hat{f}^c = \dots \quad (210)$$

$$\hat{f}^a \hat{f}^b \hat{f}^c = \frac{C_G}{2} f_{abc} \quad (211)$$

$$(\hat{f}^a \hat{f}^b - \hat{f}^b \hat{f}^a) \hat{f}^c \hat{f}^d = -\frac{C_G}{2} f_{abe} f_{cde} \quad (212)$$

$$\hat{f}^a \hat{f}^b (\hat{f}^c \hat{f}^d + \hat{f}^d \hat{f}^c) = \hat{f}^b \hat{f}^a (\hat{f}^c \hat{f}^d + \hat{f}^d \hat{f}^c) \quad (213)$$

$$\hat{f}^a \hat{f}^b \hat{f}^c \hat{f}^d = \hat{f}^b \hat{f}^a \hat{f}^d \hat{f}^c \quad (214)$$

$[\text{Coef}]_{(\mu\nu)\rho\sigma}^{(ab)cd}$ is rewritten as

$$\begin{aligned} [\text{Coef}]_{(\mu\nu)\rho\sigma}^{(ab)cd} &= -\frac{1}{4}\pi^2 \left\{ 13g^{\mu\nu} g^{\rho\sigma} (\hat{f}^b \hat{f}^a (\hat{f}^c \hat{f}^d + \hat{f}^d \hat{f}^c)) \right. \\ &\quad + g^{\mu\sigma} g^{\nu\rho} (4\hat{f}^a \hat{f}^d \hat{f}^c \hat{f}^b - 2\hat{f}^a \hat{f}^c \hat{f}^d \hat{f}^b - 3C_G f_{abj} f_{cdj}) \\ &\quad \left. + g^{\mu\rho} g^{\nu\sigma} (-2\hat{f}^a \hat{f}^d \hat{f}^c \hat{f}^b + 4\hat{f}^a \hat{f}^c \hat{f}^d \hat{f}^b + 3C_G f_{abj} f_{cdj}) \right\} \\ &= -\frac{1}{4}\pi^2 \left\{ 13g^{\mu\nu} g^{\rho\sigma} (\hat{f}^a \hat{f}^b (\hat{f}^c \hat{f}^d + \hat{f}^d \hat{f}^c)) \right. \\ &\quad \left. + g^{\mu\sigma} g^{\nu\rho} (2\hat{f}^a \hat{f}^d \hat{f}^c \hat{f}^b - 4C_G f_{abj} f_{cdj}) + g^{\mu\rho} g^{\nu\sigma} (2\hat{f}^a \hat{f}^c \hat{f}^d \hat{f}^b + 4C_G f_{abj} f_{cdj}) \right\} \quad (215) \end{aligned}$$

It is noted that $[\text{Coef}]_{(\mu\nu)\rho\sigma}^{(ab)cd}$ is symmetric under the interchange between (μ, a) and (ν, b) and also between (ρ, c) and (σ, d) , which is shown by using the formulae (213) and (214).

- The divergent part of $\Theta_{(\mu\nu)\rho\sigma}^{(ab)cdA}$ is

$$\begin{aligned}\Theta_{(\mu\nu)\rho\sigma}^{(ab)cdA} &= -\frac{g^2}{16\pi^4} \tilde{\Theta}_{(\mu\nu)\rho\sigma}^{(ab)cdA} \sim -\frac{g^2}{16\pi^4} [\text{Coef}]_{(\mu\nu)\rho\sigma}^{(ab)cd} B_0(0; \lambda^2, \lambda^2) \\ &\sim -\frac{g^2}{16\pi^4} S^\epsilon \frac{1}{\epsilon} [\text{Coef}]_{(\mu\nu)\rho\sigma}^{(ab)cd}\end{aligned}\quad (216)$$

- Adding the contributions of the other diagrams where a gluon propagator connects other pairs of the external gluon lines,

$$\begin{aligned}&([\text{Coef}]_{(\mu\nu)\rho\sigma}^{(ab)cd} + [\text{Coef}]_{(\mu\rho)\nu\sigma}^{(ac)bd} + [\text{Coef}]_{(\mu\sigma)\nu\rho}^{(ad)bc} + [\text{Coef}]_{(\nu\rho)\mu\sigma}^{(bc)ad} + [\text{Coef}]_{(\nu\sigma)\mu\rho}^{(bd)ac} + [\text{Coef}]_{(\rho\sigma)\mu\nu}^{(cd)ab}) / \left(-\frac{\pi^2}{4}\right) \\ &= 8C_G \left\{ f_{abj} f_{cdj} (g^{\mu\rho} g^{\nu\sigma} - g^{\mu\sigma} g^{\nu\rho}) + f_{acj} f_{bdj} (g^{\mu\nu} g^{\rho\sigma} - g^{\mu\sigma} g^{\nu\rho}) \right. \\ &\quad \left. + f_{adj} f_{bcj} (g^{\mu\nu} g^{\rho\sigma} - g^{\mu\rho} g^{\nu\sigma}) \right\} \\ &+ g^{\mu\nu} g^{\rho\sigma} \left\{ 26 \hat{f}^a \hat{f}^b (\hat{f}^c \hat{f}^d + \hat{f}^d \hat{f}^c) + 2 \hat{f}^a \hat{f}^c \hat{f}^d \hat{f}^b + 2 \hat{f}^a \hat{f}^d \hat{f}^c \hat{f}^b + 2 \hat{f}^b \hat{f}^c \hat{f}^d \hat{f}^a + 2 \hat{f}^b \hat{f}^d \hat{f}^c \hat{f}^a \right\} \\ &+ g^{\mu\sigma} g^{\nu\rho} \left\{ 26 \hat{f}^a \hat{f}^d (\hat{f}^b \hat{f}^c + \hat{f}^c \hat{f}^b) + 2 \hat{f}^a \hat{f}^b \hat{f}^c \hat{f}^d + 2 \hat{f}^a \hat{f}^c \hat{f}^b \hat{f}^d + 2 \hat{f}^b \hat{f}^d \hat{f}^a \hat{f}^c + 2 \hat{f}^c \hat{f}^d \hat{f}^a \hat{f}^b \right\} \\ &+ g^{\mu\rho} g^{\nu\sigma} \left\{ 26 \hat{f}^a \hat{f}^c (\hat{f}^b \hat{f}^d + \hat{f}^d \hat{f}^b) + 2 \hat{f}^a \hat{f}^b \hat{f}^d \hat{f}^c + 2 \hat{f}^a \hat{f}^d \hat{f}^b \hat{f}^c + 2 \hat{f}^b \hat{f}^c \hat{f}^a \hat{f}^d + 2 \hat{f}^c \hat{f}^d \hat{f}^b \hat{f}^a \right\} \\ &= 8C_G W_{\mu\nu\rho\sigma}^{abcd} + 30g^{\mu\nu} g^{\rho\sigma} \hat{f}^a \hat{f}^b (\hat{f}^c \hat{f}^d + \hat{f}^d \hat{f}^c) + 30g^{\mu\sigma} g^{\nu\rho} \hat{f}^a \hat{f}^d (\hat{f}^b \hat{f}^c + \hat{f}^c \hat{f}^b) \\ &\quad + 30g^{\mu\rho} g^{\nu\sigma} \hat{f}^a \hat{f}^c (\hat{f}^b \hat{f}^d + \hat{f}^d \hat{f}^b)\end{aligned}\quad (217)$$

- Finally we obtain the divergent part of $\Theta_{\mu\nu\rho\sigma}^{abcdA}$ as

$$\begin{aligned}\Theta_{\mu\nu\rho\sigma}^{abcdA} \Big|_{\text{Div}} &= \frac{g^2}{16\pi^2} S^\epsilon \frac{1}{\epsilon} \left\{ 2C_G W_{\mu\nu\rho\sigma}^{abcd} + \frac{15}{2} \left\{ g^{\mu\nu} g^{\rho\sigma} \hat{f}^a \hat{f}^b (\hat{f}^c \hat{f}^d + \hat{f}^d \hat{f}^c) \right. \right. \\ &\quad \left. \left. + g^{\mu\sigma} g^{\nu\rho} \hat{f}^a \hat{f}^d (\hat{f}^b \hat{f}^c + \hat{f}^c \hat{f}^b) + g^{\mu\rho} g^{\nu\sigma} \hat{f}^a \hat{f}^c (\hat{f}^b \hat{f}^d + \hat{f}^d \hat{f}^b) \right\} \right\}\end{aligned}\quad (218)$$

2. Type B $[\Theta_{\mu\nu\rho\sigma}^{abcdB}]$ (gluon loop contribution B)

Three diagrams contribute. See Fig.18.

◇ The first one is

$$-ig^2 \Theta_{(\mu\nu)(\rho\sigma)}^{(ab)(cd)B} = \frac{1}{2} g^2 (g\mu^\epsilon)^2 \int \frac{d^n l}{(2\pi)^n} [-iW_{\mu\nu\tau\kappa}^{abge}] [-iW_{\kappa\tau\rho\sigma}^{egcd}] \left(\frac{-i}{l^2 - \lambda^2} \right)^2 \quad (219)$$

where $\frac{1}{2}$ is a symmetric factor and we have included a small mass λ in the gluon-propagators. The UV divergence does not depend on λ in $\overline{\text{MS}}$ renormalization scheme.

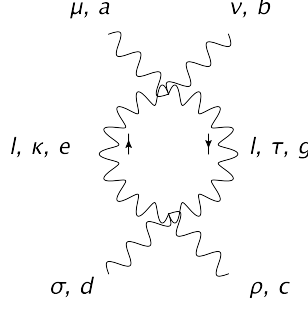

Figure 18: Four-gluon vertex (gluon-loop contribution): $\Theta_{(\mu\nu)(\rho\sigma)}^{(ab)(cd)B}$

- Using the integration formula (53), we obtain

$$\Theta_{(\mu\nu)(\rho\sigma)}^{(ab)(cd)B} = -\frac{g^2}{16\pi^2} (4\pi)^\epsilon \Gamma(\epsilon) \left[\frac{\mu^2}{\lambda^2} \right]^\epsilon \frac{1}{2} [W_{\mu\nu\tau\kappa}^{abge}] [W_{\kappa\tau\rho\sigma}^{egcd}] \quad (220)$$

where $[W_{\mu\nu\tau\kappa}^{abge}] [W_{\kappa\tau\rho\sigma}^{egcd}]$ is expressed as (see Eq. (367))

$$\begin{aligned} [W_{\mu\nu\tau\kappa}^{abge}] [W_{\kappa\tau\rho\sigma}^{egcd}] &= g^{\mu\rho} g^{\nu\sigma} \left\{ 2(\hat{f}^a \hat{f}^c \hat{f}^d \hat{f}^b) + 4C_G f^{abg} f^{cdg} \right\} \\ &+ g^{\mu\sigma} g^{\nu\rho} \left\{ 2(\hat{f}^a \hat{f}^d \hat{f}^c \hat{f}^b) - 4C_G f_{abg} f_{cdg} \right\} + 4g^{\mu\nu} g^{\rho\sigma} \left\{ \hat{f}^a \hat{f}^b (\hat{f}^c \hat{f}^d + \hat{f}^d \hat{f}^c) \right\} \end{aligned} \quad (221)$$

It is noted that $[W_{\mu\nu\tau\kappa}^{abge}] [W_{\kappa\tau\rho\sigma}^{egcd}]$ is symmetric under the interchange between (μ, a) and (ν, b) and also between (ρ, c) and (σ, d) , which is shown by using the formulae (213) and (214).

- Adding the contributions of the other diagrams obtained by taking different pairs of the external gluon lines,

$$\begin{aligned} &[W_{\mu\nu\tau\kappa}^{abge}] [W_{\kappa\tau\rho\sigma}^{egcd}] + [W_{\mu\rho\tau\kappa}^{acge}] [W_{\kappa\tau\nu\sigma}^{egbd}] + [W_{\mu\sigma\tau\kappa}^{adge}] [W_{\kappa\tau\nu\rho}^{egbc}] \\ &= 4C_G \left\{ f_{abg} f_{cdg} (g^{\mu\rho} g^{\nu\sigma} - g^{\mu\sigma} g^{\nu\rho}) + f_{acg} f_{bdg} (g^{\mu\nu} g^{\rho\sigma} - g^{\mu\sigma} g^{\nu\rho}) \right. \\ &\quad \left. + f_{adg} f_{bcg} (g^{\mu\nu} g^{\rho\sigma} - g^{\mu\rho} g^{\nu\sigma}) \right\} \\ &+ g^{\mu\nu} g^{\rho\sigma} \left\{ 4\hat{f}^a \hat{f}^b (\hat{f}^c \hat{f}^d + \hat{f}^d \hat{f}^c) + 2\hat{f}^a \hat{f}^b (\hat{f}^c \hat{f}^d + \hat{f}^d \hat{f}^c) \right\} \\ &+ g^{\mu\sigma} g^{\nu\rho} \left\{ 4\hat{f}^a \hat{f}^d (\hat{f}^b \hat{f}^c + \hat{f}^c \hat{f}^b) + 2\hat{f}^a \hat{f}^d (\hat{f}^b \hat{f}^c + \hat{f}^c \hat{f}^b) \right\} \\ &+ g^{\mu\rho} g^{\nu\sigma} \left\{ 4\hat{f}^a \hat{f}^c (\hat{f}^b \hat{f}^d + \hat{f}^d \hat{f}^b) + 2\hat{f}^a \hat{f}^c (\hat{f}^b \hat{f}^d + \hat{f}^d \hat{f}^b) \right\} \\ &= 4C_G W_{\mu\nu\rho\sigma}^{abcd} + 6g^{\mu\nu} g^{\rho\sigma} \hat{f}^a \hat{f}^b (\hat{f}^c \hat{f}^d + \hat{f}^d \hat{f}^c) \\ &+ 6g^{\mu\sigma} g^{\nu\rho} \hat{f}^a \hat{f}^d (\hat{f}^b \hat{f}^c + \hat{f}^c \hat{f}^b) + 6g^{\mu\rho} g^{\nu\sigma} \hat{f}^a \hat{f}^c (\hat{f}^b \hat{f}^d + \hat{f}^d \hat{f}^b) \end{aligned} \quad (222)$$

- The divergent part of $\Theta_{\mu\nu\rho\sigma}^{abcdB}$ is

$$\Theta_{\mu\nu\rho\sigma}^{abcdB} \Big|_{\text{Div}} = -\frac{g^2}{16\pi^2} S^\epsilon \frac{1}{\epsilon} \left\{ 2C_G W_{\mu\nu\rho\sigma}^{abcd} + 3g^{\mu\nu} g^{\rho\sigma} \hat{f}^a \hat{f}^b (\hat{f}^c \hat{f}^d + \hat{f}^d \hat{f}^c) \right\}$$

$$+3g^{\mu\sigma}g^{\nu\rho}\hat{f}^a\hat{f}^d(\hat{f}^b\hat{f}^c + \hat{f}^c\hat{f}^b) + 3g^{\mu\rho}g^{\nu\sigma}\hat{f}^a\hat{f}^c(\hat{f}^b\hat{f}^d + \hat{f}^d\hat{f}^b)\} \quad (223)$$

3. Type C $[\Theta_{\mu\nu\rho\sigma}^{abcdC}]$ (gluon loop contribution C)

Three diagrams contribute. See Fig.19. Others are obtained by reflection-free permutation (rosary permutation) of $(\mu, a), (\nu, b), (\rho, c)$ and (σ, d) .

◇ The first one is

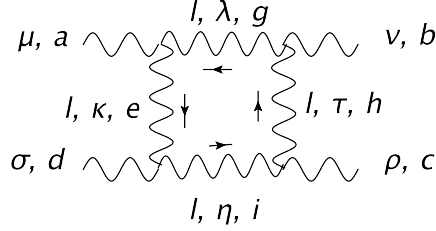

Figure 19: Four-gluon vertex (gluon-loop contribution): $\Theta_{\mu\nu\rho\sigma}^{abcdC}$

$$\begin{aligned} -ig^2\Theta_{\mu\nu\rho\sigma}^{abcdC} &= g^2(g\mu^\epsilon)^2 \int \frac{d^n l}{(2\pi)^n} [f^{eag}V^{\kappa\mu\lambda}(-l, 0, l)] [f^{gbh}V^{\lambda\nu\tau}(-l, 0, l)] \\ &\quad \times [f^{hci}V^{\tau\rho\eta}(-l, 0, l)] [f^{ide}V^{\eta\sigma\kappa}(-l, 0, l)] \left(\frac{-i}{l^2 - \lambda^2}\right)^4 \quad (224) \end{aligned}$$

where we have included a small mass λ in the gluon-propagators. The UV divergence does not depend on λ in $\overline{\text{MS}}$ renormalization scheme.

- $f^{eag}f^{gbh}f^{hci}f^{ide} = \hat{f}^a\hat{f}^b\hat{f}^c\hat{f}^d$
- With help of FeynCalc,

$$\begin{aligned} &V^{\kappa\mu\lambda}(-l, 0, l)V^{\lambda\nu\tau}(-l, 0, l)V^{\tau\rho\eta}(-l, 0, l)V^{\eta\sigma\kappa}(-l, 0, l) \\ &= (l^2)^2 (g^{\mu\nu}g^{\rho\sigma} + g^{\mu\sigma}g^{\nu\rho}) + 3l^2 (l^\mu l^\nu g^{\rho\sigma} + l^\nu l^\rho g^{\mu\sigma} + l^\mu l^\sigma g^{\nu\rho} + l^\rho l^\sigma g^{\mu\nu}) \\ &\quad + 34l^\mu l^\nu l^\rho l^\sigma \quad (225) \end{aligned}$$

- Using the following formulae,

$$\begin{aligned} \int \frac{d^n l}{(2\pi)^n} \frac{(l^2)^2}{[l^2 - m^2]^4} &= \int \frac{d^n l}{(2\pi)^n} \frac{1}{[l^2 - m^2]^2} + \text{finite} \\ &= \frac{i}{16\pi^2} (4\pi)^\epsilon \frac{\Gamma(\epsilon)}{[m^2]^\epsilon} + \text{finite} \quad (226) \end{aligned}$$

$$\begin{aligned} \int \frac{d^n l}{(2\pi)^n} \frac{l^2 l^\mu l^\nu}{[l^2 - m^2]^4} &= \int \frac{d^n l}{(2\pi)^n} \frac{l^\mu l^\nu}{[l^2 - m^2]^3} + \text{finite} \\ &= \frac{i}{16\pi^2} (4\pi)^\epsilon \frac{\Gamma(\epsilon)}{4[m^2]^\epsilon} g^{\mu\nu} + \text{finite} \quad (227) \end{aligned}$$

$$\int \frac{d^n l}{(2\pi)^n} \frac{l^\mu l^\nu l^\rho l^\sigma}{[l^2 - m^2]^4} = \frac{i}{16\pi^2} (4\pi)^\epsilon \frac{\Gamma(\epsilon)}{24[m^2]^\epsilon} \{g^{\mu\nu} g^{\rho\sigma} + g^{\mu\rho} g^{\nu\sigma} + g^{\mu\sigma} g^{\nu\rho}\}, \quad (228)$$

the divergent part of $\Theta_{[\mu\nu\rho\sigma]}^{[abcd]C}$ is evaluated as

$$\begin{aligned} \Theta_{[\mu\nu\rho\sigma]}^{[abcd]C} \Big|_{UV} &= \hat{f}^a \hat{f}^b \hat{f}^c \hat{f}^d \frac{-g^2}{16\pi^2} S^\epsilon \frac{1}{\epsilon} \left[\frac{5}{2} (g^{\mu\nu} g^{\rho\sigma} + g^{\mu\sigma} g^{\nu\rho}) \right. \\ &\quad \left. + \frac{17}{12} (g^{\mu\nu} g^{\rho\sigma} + g^{\mu\rho} g^{\nu\sigma} + g^{\mu\sigma} g^{\nu\rho}) \right] \end{aligned} \quad (229)$$

It is noted that $\Theta_{[\mu\nu\rho\sigma]}^{[abcd]C}$ is symmetric under the interchange between (μ, a) and (ρ, c) and also between (ν, b) and (σ, d) , i.e., reflection-free, which is shown by using the formula (214).

- Adding the contributions of the three diagrams

$$\begin{aligned} &(\Theta_{[\mu\nu\rho\sigma]}^{[abcd]C} + \Theta_{[\mu\nu\sigma\rho]}^{[abdc]C} + \Theta_{[\mu\rho\nu\sigma]}^{[acbd]C}) / \left(\frac{-g^2}{16\pi^2} S^\epsilon \frac{1}{\epsilon} \right) \\ &= g^{\mu\nu} g^{\rho\sigma} \left\{ \frac{5}{2} (\hat{f}^a \hat{f}^b \hat{f}^c \hat{f}^d + \hat{f}^a \hat{f}^b \hat{f}^d \hat{f}^c) + \frac{17}{12} [\hat{f}^a \hat{f}^b \hat{f}^c \hat{f}^d + \hat{f}^a \hat{f}^b \hat{f}^d \hat{f}^c + \hat{f}^a \hat{f}^c \hat{f}^b \hat{f}^d] \right\} \\ &\quad + g^{\mu\sigma} g^{\nu\rho} \left\{ \frac{5}{2} (\hat{f}^a \hat{f}^b \hat{f}^c \hat{f}^d + \hat{f}^a \hat{f}^c \hat{f}^b \hat{f}^d) + \frac{17}{12} [\hat{f}^a \hat{f}^b \hat{f}^c \hat{f}^d + \hat{f}^a \hat{f}^b \hat{f}^d \hat{f}^c + \hat{f}^a \hat{f}^c \hat{f}^b \hat{f}^d] \right\} \\ &\quad + g^{\mu\rho} g^{\nu\sigma} \left\{ \frac{5}{2} (\hat{f}^a \hat{f}^b \hat{f}^d \hat{f}^c + \hat{f}^a \hat{f}^c \hat{f}^b \hat{f}^d) + \frac{17}{12} [\hat{f}^a \hat{f}^b \hat{f}^c \hat{f}^d + \hat{f}^a \hat{f}^b \hat{f}^d \hat{f}^c + \hat{f}^a \hat{f}^c \hat{f}^b \hat{f}^d] \right\} \end{aligned} \quad (230)$$

- Finally we obtain the divergent part of $\Theta_{\mu\nu\rho\sigma}^{abcdC}$ as

$$\begin{aligned} \Theta_{\mu\nu\rho\sigma}^{abcdC} &= \frac{g^2}{16\pi^2} S^\epsilon \frac{1}{\epsilon} \left\{ -\frac{5}{2} [g^{\mu\nu} g^{\rho\sigma} (\hat{f}^a \hat{f}^b \hat{f}^c \hat{f}^d + \hat{f}^a \hat{f}^b \hat{f}^d \hat{f}^c) \right. \\ &\quad + g^{\mu\sigma} g^{\nu\rho} (\hat{f}^a \hat{f}^b \hat{f}^c \hat{f}^d + \hat{f}^a \hat{f}^c \hat{f}^b \hat{f}^d) + g^{\mu\rho} g^{\nu\sigma} (\hat{f}^a \hat{f}^b \hat{f}^d \hat{f}^c + \hat{f}^a \hat{f}^c \hat{f}^b \hat{f}^d)] \\ &\quad \left. - \frac{17}{12} (g^{\mu\nu} g^{\rho\sigma} + g^{\mu\sigma} g^{\nu\rho} + g^{\mu\rho} g^{\nu\sigma}) [\hat{f}^a \hat{f}^b \hat{f}^c \hat{f}^d + \hat{f}^a \hat{f}^b \hat{f}^d \hat{f}^c + \hat{f}^a \hat{f}^c \hat{f}^b \hat{f}^d] \right\} \end{aligned} \quad (231)$$

4. Type D $[\Theta_{\mu\nu\rho\sigma}^{abcdD}]$ (ghost-loop contribution)

Six diagrams contribute. See Fig.20. Others are obtained by permutation of (μ, a) , (ν, b) , (ρ, c) and (σ, d) .

◇ The first one is

$$\begin{aligned} -ig^2 \Theta_{\mu\nu\rho\sigma}^{abcdD(1)} &= (-1) g^2 (g\mu^\epsilon)^2 \int \frac{d^n l}{(2\pi)^n} (-f^{eag} l_\mu) (-f^{gbh} l_\nu) (-f^{hci} l_\rho) (-f^{ide} l_\sigma) \\ &\quad \times \left(\frac{i}{l^2 - \lambda^2} \right)^4 \end{aligned} \quad (232)$$

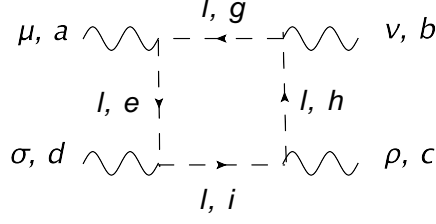

Figure 20: Four-gluon vertex (ghost-loop contribution): $\Theta_{\mu\nu\rho\sigma}^{abcdD(1)}$

where we have included a small mass λ in the ghost-propagators. The UV divergence does not depend on λ in $\overline{\text{MS}}$ renormalization scheme.

- Since

$$\int \frac{d^n l}{(2\pi)^n} \frac{l^\mu l^\nu l^\rho l^\sigma}{[l^2 - \lambda^2]^4} = \frac{i}{16\pi^2} (4\pi)^\epsilon \frac{\Gamma(\epsilon)}{24[\lambda^2]^\epsilon} \{g^{\mu\nu} g^{\rho\sigma} + g^{\mu\rho} g^{\nu\sigma} + g^{\mu\sigma} g^{\nu\rho}\}, \quad (233)$$

we obtain

$$\Theta_{\mu\nu\rho\sigma}^{abcdD(1)} = \frac{g^2}{16\pi^2} (4\pi)^\epsilon \Gamma(\epsilon) \left[\frac{\mu^2}{\lambda^2}\right]^\epsilon \frac{1}{24} \{g^{\mu\nu} g^{\rho\sigma} + g^{\mu\rho} g^{\nu\sigma} + g^{\mu\sigma} g^{\nu\rho}\} \times (\hat{f}^a \hat{f}^b \hat{f}^c \hat{f}^d) \quad (234)$$

- Adding the contributions of the six diagrams, we find that the divergent part is

$$\Theta_{\mu\nu\rho\sigma}^{abcdD} \sim \frac{g^2}{16\pi^2} S^\epsilon \frac{1}{\epsilon} \times \frac{1}{24} \{g^{\mu\nu} g^{\rho\sigma} + g^{\mu\rho} g^{\nu\sigma} + g^{\mu\sigma} g^{\nu\rho}\} \times (\hat{f}^a \hat{f}^b \hat{f}^c \hat{f}^d + \hat{f}^a \hat{f}^b \hat{f}^d \hat{f}^c + \hat{f}^a \hat{f}^c \hat{f}^b \hat{f}^d + \hat{f}^a \hat{f}^c \hat{f}^d \hat{f}^b + \hat{f}^a \hat{f}^d \hat{f}^b \hat{f}^c + \hat{f}^a \hat{f}^d \hat{f}^c \hat{f}^b) \quad (235)$$

5. Interim summary (Sum of the diagrams of Type A to Type D) (gluon and ghost contributions)

- There appear six factors, $\hat{f}^a \hat{f}^b \hat{f}^c \hat{f}^d$, $\hat{f}^a \hat{f}^b \hat{f}^d \hat{f}^c$, $\hat{f}^a \hat{f}^c \hat{f}^b \hat{f}^d$, $\hat{f}^a \hat{f}^c \hat{f}^d \hat{f}^b$, $\hat{f}^a \hat{f}^d \hat{f}^b \hat{f}^c$ and $\hat{f}^a \hat{f}^d \hat{f}^c \hat{f}^b$. But they are not all independent; there exist the three relations which are derived from (210) and (214):

$$\hat{f}^a \hat{f}^c \hat{f}^d \hat{f}^b = \hat{f}^a \hat{f}^b \hat{f}^d \hat{f}^c, \quad \hat{f}^a \hat{f}^d \hat{f}^b \hat{f}^c = \hat{f}^a \hat{f}^c \hat{f}^b \hat{f}^d, \quad \hat{f}^a \hat{f}^d \hat{f}^c \hat{f}^b = \hat{f}^a \hat{f}^b \hat{f}^c \hat{f}^d \quad (236)$$

We choose $\hat{f}^a \hat{f}^b \hat{f}^c \hat{f}^d$, $\hat{f}^a \hat{f}^b \hat{f}^d \hat{f}^c$ and $\hat{f}^a \hat{f}^c \hat{f}^b \hat{f}^d$ as independent factors.

- In terms of the above independent factors, the divergent parts of the contributions of Type A to Type D are written as

$$\Theta_{\mu\nu\rho\sigma}^{abcdA} / \left(\frac{g^2}{16\pi^2} S^\epsilon \frac{1}{\epsilon} \right) \sim 2C_G W_{\mu\nu\rho\sigma}^{abcd} + \frac{15}{2} \left\{ g^{\mu\nu} g^{\rho\sigma} [\hat{f}^a \hat{f}^b \hat{f}^c \hat{f}^d + \hat{f}^a \hat{f}^b \hat{f}^d \hat{f}^c] \right. \\ \left. + g^{\mu\rho} g^{\nu\sigma} [\hat{f}^a \hat{f}^b \hat{f}^d \hat{f}^c + \hat{f}^a \hat{f}^c \hat{f}^b \hat{f}^d] + g^{\mu\sigma} g^{\nu\rho} [\hat{f}^a \hat{f}^c \hat{f}^b \hat{f}^d + \hat{f}^a \hat{f}^b \hat{f}^c \hat{f}^d] \right\} \quad (237)$$

$$\Theta_{\mu\nu\rho\sigma}^{abcdB} / \left(\frac{g^2}{16\pi^2} S^\epsilon \frac{1}{\epsilon} \right) \sim -2C_G W_{\mu\nu\rho\sigma}^{abcd} - 3 \left\{ g^{\mu\nu} g^{\rho\sigma} [\hat{f}^a \hat{f}^b \hat{f}^c \hat{f}^d + \hat{f}^a \hat{f}^b \hat{f}^d \hat{f}^c] \right. \\ \left. + g^{\mu\rho} g^{\nu\sigma} [\hat{f}^a \hat{f}^b \hat{f}^d \hat{f}^c + \hat{f}^a \hat{f}^c \hat{f}^b \hat{f}^d] + g^{\mu\sigma} g^{\nu\rho} [\hat{f}^a \hat{f}^c \hat{f}^b \hat{f}^d + \hat{f}^a \hat{f}^b \hat{f}^c \hat{f}^d] \right\} \quad (238)$$

$$\Theta_{\mu\nu\rho\sigma}^{abcdC} / \left(\frac{g^2}{16\pi^2} S^\epsilon \frac{1}{\epsilon} \right) \sim -\frac{5}{2} \left\{ g^{\mu\nu} g^{\rho\sigma} [\hat{f}^a \hat{f}^b \hat{f}^c \hat{f}^d + \hat{f}^a \hat{f}^b \hat{f}^d \hat{f}^c] \right. \\ \left. + g^{\mu\rho} g^{\nu\sigma} [\hat{f}^a \hat{f}^b \hat{f}^d \hat{f}^c + \hat{f}^a \hat{f}^c \hat{f}^b \hat{f}^d] + g^{\mu\sigma} g^{\nu\rho} [\hat{f}^a \hat{f}^c \hat{f}^b \hat{f}^d + \hat{f}^a \hat{f}^b \hat{f}^c \hat{f}^d] \right\} \\ - \frac{17}{12} (g^{\mu\nu} g^{\rho\sigma} + g^{\mu\sigma} g^{\nu\rho} + g^{\mu\rho} g^{\nu\sigma}) [\hat{f}^a \hat{f}^b \hat{f}^c \hat{f}^d + \hat{f}^a \hat{f}^b \hat{f}^d \hat{f}^c + \hat{f}^a \hat{f}^c \hat{f}^b \hat{f}^d] \quad (239)$$

$$\Theta_{\mu\nu\rho\sigma}^{abcdD} / \left(\frac{g^2}{16\pi^2} S^\epsilon \frac{1}{\epsilon} \right) \sim \frac{1}{12} (g^{\mu\nu} g^{\rho\sigma} + g^{\mu\sigma} g^{\nu\rho} + g^{\mu\rho} g^{\nu\sigma}) \\ \times [\hat{f}^a \hat{f}^b \hat{f}^c \hat{f}^d + \hat{f}^a \hat{f}^b \hat{f}^d \hat{f}^c + \hat{f}^a \hat{f}^c \hat{f}^b \hat{f}^d] \quad (240)$$

- The sum of the contributions of Type A to Type D:

$$\text{Sum}^{ABCD} \equiv \left(\Theta_{\mu\nu\rho\sigma}^{abcdA} + \Theta_{\mu\nu\rho\sigma}^{abcdB} + \Theta_{\mu\nu\rho\sigma}^{abcdC} + \Theta_{\mu\nu\rho\sigma}^{abcdD} \right) \Big|_{\text{Div}} / \left(\frac{g^2}{16\pi^2} S^\epsilon \frac{1}{\epsilon} \right) \\ = 2 \left\{ g^{\mu\nu} g^{\rho\sigma} [\hat{f}^a \hat{f}^b \hat{f}^c \hat{f}^d + \hat{f}^a \hat{f}^b \hat{f}^d \hat{f}^c] + g^{\mu\rho} g^{\nu\sigma} [\hat{f}^a \hat{f}^b \hat{f}^d \hat{f}^c + \hat{f}^a \hat{f}^c \hat{f}^b \hat{f}^d] \right. \\ \left. + g^{\mu\sigma} g^{\nu\rho} [\hat{f}^a \hat{f}^c \hat{f}^b \hat{f}^d + \hat{f}^a \hat{f}^b \hat{f}^c \hat{f}^d] \right\} \\ - \frac{4}{3} (g^{\mu\nu} g^{\rho\sigma} + g^{\mu\sigma} g^{\nu\rho} + g^{\mu\rho} g^{\nu\sigma}) [\hat{f}^a \hat{f}^b \hat{f}^c \hat{f}^d + \hat{f}^a \hat{f}^b \hat{f}^d \hat{f}^c + \hat{f}^a \hat{f}^c \hat{f}^b \hat{f}^d] \\ = g^{\mu\nu} g^{\rho\sigma} \times \frac{2}{3} \left\{ [\hat{f}^a \hat{f}^b \hat{f}^c \hat{f}^d - \hat{f}^a \hat{f}^c \hat{f}^b \hat{f}^d] + [\hat{f}^a \hat{f}^b \hat{f}^d \hat{f}^c - \hat{f}^a \hat{f}^c \hat{f}^b \hat{f}^d] \right\} \\ + g^{\mu\rho} g^{\nu\sigma} \times \frac{2}{3} \left\{ [\hat{f}^a \hat{f}^b \hat{f}^d \hat{f}^c - \hat{f}^a \hat{f}^b \hat{f}^c \hat{f}^d] + [\hat{f}^a \hat{f}^c \hat{f}^b \hat{f}^d - \hat{f}^a \hat{f}^b \hat{f}^c \hat{f}^d] \right\} \\ + g^{\mu\sigma} g^{\nu\rho} \times \frac{2}{3} \left\{ [\hat{f}^a \hat{f}^c \hat{f}^b \hat{f}^d - \hat{f}^a \hat{f}^b \hat{f}^d \hat{f}^c] + [\hat{f}^a \hat{f}^b \hat{f}^c \hat{f}^d - \hat{f}^a \hat{f}^b \hat{f}^d \hat{f}^c] \right\} \quad (241)$$

- Using the relation (212), we find

$$\hat{f}^a \hat{f}^b \hat{f}^c \hat{f}^d - \hat{f}^a \hat{f}^c \hat{f}^b \hat{f}^d = (\hat{f}^b \hat{f}^c - \hat{f}^c \hat{f}^b) \hat{f}^d \hat{f}^a = \frac{C_G}{2} f^{abc} f^{bce} \quad (242)$$

$$\hat{f}^a \hat{f}^b \hat{f}^d \hat{f}^c - \hat{f}^a \hat{f}^c \hat{f}^b \hat{f}^d = \frac{C_G}{2} f^{ace} f^{bde} \quad (243)$$

$$\hat{f}^a \hat{f}^b \hat{f}^d \hat{f}^c - \hat{f}^a \hat{f}^b \hat{f}^c \hat{f}^d = \frac{C_G}{2} f^{abe} f^{cde} \quad (244)$$

Therefore, we obtain

$$\begin{aligned}
\text{Sum}^{ABCD} &= \frac{1}{3}C_G \left\{ g^{\mu\nu} g^{\rho\sigma} (f^{ade} f^{bce} + f^{ace} f^{bde}) + g^{\mu\rho} g^{\nu\sigma} (f^{abe} f^{cde} - f^{ade} f^{bce}) \right. \\
&\quad \left. + g^{\mu\sigma} g^{\nu\rho} (-f^{ace} f^{bde} - f^{abe} f^{cde}) \right\} \\
&= \frac{1}{3}C_G W_{\mu\nu\rho\sigma}^{abcd}
\end{aligned} \tag{245}$$

where the expression of $W_{\mu\nu\rho\sigma}^{abcd}$ is given in Eq.(124).

6. Type E $[\Theta_{\mu\nu\rho\sigma}^{abcdE}]$ (quark-loop contribution)

Six diagrams contribute. See Fig.21. Others are obtained by permutation of (μ, a) , (ν, b) , (ρ, c) and (σ, d) .

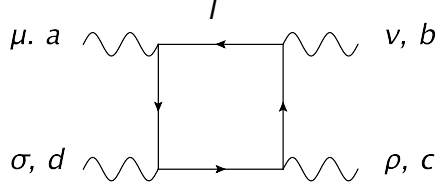

Figure 21: Four-gluon vertex (quark-loop contribution): $\Theta_{\mu\nu\rho\sigma}^{abcdE(1)}$

◇ The first one is

$$\begin{aligned}
-i g^2 \Theta_{\mu\nu\rho\sigma}^{abcdE(1)} &= (-1) g^2 (g\mu^\epsilon)^2 \int \frac{d^n l}{(2\pi)^n} \text{Tr} \left[(i\gamma^\mu T^a) \frac{i}{\not{l} - m} (i\gamma^\nu T^b) \frac{i}{\not{l} - m} (i\gamma^\rho T^c) \right. \\
&\quad \left. \times \frac{i}{\not{l} - m} (i\gamma^\sigma T^d) \frac{i}{\not{l} - m} \right]
\end{aligned} \tag{246}$$

• We evaluate

$$\tilde{\Theta}_{\mu\nu\rho\sigma}^{abcdE} \equiv \text{tr} [T^a T^b T^c T^d] \int \frac{d^n l}{(2\pi)^n} \frac{\text{Tr} [\gamma^\mu \not{l} \gamma^\nu \not{l} \gamma^\rho \not{l} \gamma^\sigma \not{l}]}{(l^2 - m^2)^4} \tag{247}$$

where we set $m = 0$ in the numerator, since the terms proportional to m^2 and m^4 are irrelevant for the UV divergence. We obtain

$$\begin{aligned}
\text{Tr} [\gamma^\mu \not{l} \gamma^\nu \not{l} \gamma^\rho \not{l} \gamma^\sigma \not{l}] &= 4 \left\{ (l^2)^2 [g^{\mu\sigma} g^{\nu\rho} - g^{\mu\rho} g^{\nu\sigma} + g^{\mu\nu} g^{\rho\sigma}] \right. \\
&\quad \left. - 2l^2 [l^\mu l^\nu g^{\rho\sigma} + l^\nu l^\rho g^{\mu\sigma} + l^\mu l^\sigma g^{\nu\rho} + l^\rho l^\sigma g^{\mu\nu}] + 8l^\mu l^\nu l^\rho l^\sigma \right\}
\end{aligned} \tag{248}$$

and using the integration formulae given in (226)-(228), the divergent part of $\tilde{\Theta}_{\mu\nu\rho\sigma}^{abcdE}$ is evaluated as

$$\tilde{\Theta}_{\mu\nu\rho\sigma}^{abcdE} \Big|_{UV} = \text{tr} [T^a T^b T^c T^d] \frac{i}{16\pi^2} (4\pi)^\epsilon \frac{\Gamma(\epsilon)}{[m^2]^\epsilon} \frac{4}{3} [g^{\mu\nu} g^{\rho\sigma} - 2g^{\mu\rho} g^{\nu\sigma} + g^{\mu\sigma} g^{\nu\rho}] \tag{249}$$

- Adding the contributions of the six diagrams

$$\begin{aligned}
& \tilde{\Theta}_{\mu\nu\rho\sigma}^{abcdE} + \tilde{\Theta}_{\mu\nu\sigma\rho}^{abcdE} + \tilde{\Theta}_{\mu\rho\nu\sigma}^{abcdE} + \tilde{\Theta}_{\mu\rho\sigma\nu}^{abcdE} + \tilde{\Theta}_{\mu\sigma\nu\rho}^{abcdE} + \tilde{\Theta}_{\mu\sigma\rho\nu}^{abcdE} \\
& \sim \text{tr}[T^a T^b T^c T^d] [g^{\mu\nu} g^{\rho\sigma} - 2g^{\mu\rho} g^{\nu\sigma} + g^{\mu\sigma} g^{\nu\rho}] + \text{tr}[T^a T^b T^d T^c] [g^{\mu\nu} g^{\rho\sigma} - 2g^{\mu\sigma} g^{\nu\rho} + g^{\mu\rho} g^{\nu\sigma}] \\
& \quad + \text{tr}[T^a T^c T^b T^d] [g^{\mu\rho} g^{\nu\sigma} - 2g^{\mu\nu} g^{\rho\sigma} + g^{\mu\sigma} g^{\nu\rho}] + \text{tr}[T^a T^c T^d T^b] [g^{\mu\rho} g^{\nu\sigma} - 2g^{\mu\sigma} g^{\nu\rho} + g^{\mu\nu} g^{\rho\sigma}] \\
& \quad + \text{tr}[T^a T^d T^b T^c] [g^{\mu\sigma} g^{\nu\rho} - 2g^{\mu\nu} g^{\rho\sigma} + g^{\mu\rho} g^{\nu\sigma}] + \text{tr}[T^a T^d T^c T^b] [g^{\mu\sigma} g^{\nu\rho} - 2g^{\mu\rho} g^{\nu\sigma} + g^{\mu\nu} g^{\rho\sigma}] \\
& = g^{\mu\nu} g^{\rho\sigma} \left\{ \text{tr}[T^a T^b T^c T^d] + \text{tr}[T^a T^b T^d T^c] - 2\text{tr}[T^a T^c T^b T^d] \right. \\
& \quad \left. + \text{tr}[T^a T^c T^d T^b] - 2\text{tr}[T^a T^d T^b T^c] + \text{tr}[T^a T^d T^c T^b] \right\} \\
& + g^{\mu\rho} g^{\nu\sigma} \left\{ -2\text{tr}[T^a T^b T^c T^d] + \text{tr}[T^a T^b T^d T^c] + \text{tr}[T^a T^c T^b T^d] \right. \\
& \quad \left. + \text{tr}[T^a T^c T^d T^b] + \text{tr}[T^a T^d T^b T^c] - 2\text{tr}[T^a T^d T^c T^b] \right\} \\
& + g^{\mu\sigma} g^{\nu\rho} \left\{ \text{tr}[T^a T^b T^c T^d] - 2\text{tr}[T^a T^b T^d T^c] + \text{tr}[T^a T^c T^b T^d] \right. \\
& \quad \left. - 2\text{tr}[T^a T^c T^d T^b] + \text{tr}[T^a T^d T^b T^c] + \text{tr}[T^a T^d T^c T^b] \right\} \\
& = g^{\mu\nu} g^{\rho\sigma} \left\{ -\text{tr}([T^a, T^d][T^b, T^c]) - \text{tr}([T^a, T^c][T^b, T^d]) \right\} \\
& \quad + g^{\mu\rho} g^{\nu\sigma} \left\{ -\text{tr}([T^a, T^b][T^c, T^d]) + \text{tr}([T^a, T^d][T^b, T^c]) \right\} \\
& \quad + g^{\mu\sigma} g^{\nu\rho} \left\{ \text{tr}([T^a, T^b][T^c, T^d]) + \text{tr}([T^a, T^c][T^b, T^d]) \right\} \\
& = g^{\mu\nu} g^{\rho\sigma} \left\{ f^{ade} f^{bce} + f^{ace} f^{bde} \right\} T_R + g^{\mu\rho} g^{\nu\sigma} \left\{ f^{abe} f^{cde} - f^{ade} f^{bce} \right\} T_R \\
& \quad + g^{\mu\sigma} g^{\nu\rho} \left\{ -f^{abe} f^{cde} - f^{ace} f^{bde} \right\} T_R \\
& = W_{\mu\nu\rho\sigma}^{abcd} T_R
\end{aligned} \tag{250}$$

where the expression of $W_{\mu\nu\rho\sigma}^{abcd}$ is given in Eq.(124).

- Thus we find

$$\begin{aligned}
\Theta_{\mu\nu\rho\sigma}^{abcdE} & \sim -i(g\mu^\epsilon)^2 \frac{i}{16\pi^2} (4\pi)^\epsilon \frac{\Gamma(\epsilon)}{[m^2]^\epsilon} \frac{4}{3} T_R W_{\mu\nu\rho\sigma}^{abcd} \\
& = \frac{g^2}{16\pi^2} (4\pi)^\epsilon \Gamma(\epsilon) \left(\frac{\mu^2}{m^2}\right)^\epsilon \frac{4}{3} T_R W_{\mu\nu\rho\sigma}^{abcd}
\end{aligned} \tag{251}$$

- Summing over all active quark flavors, which gives the number n_f , we finally obtain for the divergent part of $\Theta_{\mu\nu\rho\sigma}^{abcdD}$ as

$$-i g^2 \Theta_{\mu\nu\rho\sigma}^{abcdE} \sim -i g^2 W_{\mu\nu\rho\sigma}^{abcd} \times \frac{g^2}{16\pi^2} S^\epsilon \frac{1}{\epsilon} \frac{4}{3} n_f T_R \tag{252}$$

7. Summary of $\Theta_{\mu\nu\rho\sigma}^{abcd}$

Adding five types of contributions to $\Theta_{\mu\nu\rho\sigma}^{abcd}$, we obtain from (245) and (252)

$$\begin{aligned}
-i g^2 \Theta_{\mu\nu\rho\sigma}^{abcd} & = -i g^2 \left\{ \Theta_{\mu\nu\rho\sigma}^{abcdA} + \Theta_{\mu\nu\rho\sigma}^{abcdB} + \Theta_{\mu\nu\rho\sigma}^{abcdC} + \Theta_{\mu\nu\rho\sigma}^{abcdD} + \Theta_{\mu\nu\rho\sigma}^{abcdE} \right\} \\
& \sim -i g^2 W_{\mu\nu\rho\sigma}^{abcd} \times \frac{g^2}{16\pi^2} S^\epsilon \frac{1}{\epsilon} \left(\frac{1}{3} C_G + \frac{4}{3} n_f T_R \right)
\end{aligned} \tag{253}$$

Therefore, we obtain

$$Z_1^{4g(1)}(\alpha_s) = \frac{\alpha_s}{4\pi} S^\epsilon \frac{1}{\epsilon} \left(-\frac{1}{3}C_G - \frac{4}{3}n_f T_R \right) \quad (254)$$

3.5.9 Check of Slavnov-Taylor identities in one-loop order

From Eqs.(163), (155), (176), (167), (254) and (151), we obtain

$$Z_1^{(1)} - Z_2^{(1)} = \frac{\alpha_s}{4\pi} S^\epsilon \frac{1}{\epsilon} \left[(-C_F - C_G) - (-C_F) \right] = \frac{\alpha_s}{4\pi} S^\epsilon \frac{1}{\epsilon} (-C_G) \quad (255)$$

$$Z_1^{FP(1)} - \tilde{Z}_2^{(1)} = \frac{\alpha_s}{4\pi} S^\epsilon \frac{1}{\epsilon} \left[\left(-\frac{1}{2}C_G\right) - \left(\frac{1}{2}C_G\right) \right] = \frac{\alpha_s}{4\pi} S^\epsilon \frac{1}{\epsilon} (-C_G) \quad (256)$$

$$Z_1^{3g(1)} - Z_3^{(1)} = \frac{\alpha_s}{4\pi} S^\epsilon \frac{1}{\epsilon} \left[\left(\frac{2}{3}C_G - \frac{4}{3}n_f T_R\right) - \left(\frac{5}{3}C_G - \frac{4}{3}n_f T_R\right) \right] = \frac{\alpha_s}{4\pi} S^\epsilon \frac{1}{\epsilon} (-C_G) \quad (257)$$

$$Z_1^{4g(1)} - Z_1^{3g(1)} = \frac{\alpha_s}{4\pi} S^\epsilon \frac{1}{\epsilon} \left[\left(-\frac{1}{3}C_G - \frac{4}{3}n_f T_R\right) - \left(\frac{2}{3}C_G - \frac{4}{3}n_f T_R\right) \right] = \frac{\alpha_s}{4\pi} S^\epsilon \frac{1}{\epsilon} (-C_G) \quad (258)$$

Indeed we observe that the Slavnov-Taylor identities hold at the level of one-loop order.

4 Asymptotic freedom

4.1 Running coupling constant in QED

In Sec.2.6.4, we have seen that the effective electric charge becomes larger at small distances. It is due to the vacuum polarization. Eq.(97) gives

$$\alpha_{\text{eff}}(q^2) = \frac{\alpha}{1 - \frac{\alpha}{3\pi} \left(\log \frac{-q^2}{Am^2} \right)}$$

As $\log \frac{-q^2}{Am^2}$ gets large (equivalently, the charge is observed at a closer distance), $\alpha_{\text{eff}}(q^2)$ increases.

[Vacuum polarization]

- According to the uncertainty principle, $\Delta E \Delta t \approx \hbar$, electron-positron creation and annihilation are taking place in the vacuum for a short period $\Delta t \leq \hbar/(2mc^2)$. Virtual e^+e^- pairs make the vacuum a dielectric medium which has an effect of screening the true charge.
- Closer we get to electric charge, we observe that the charge becomes stronger

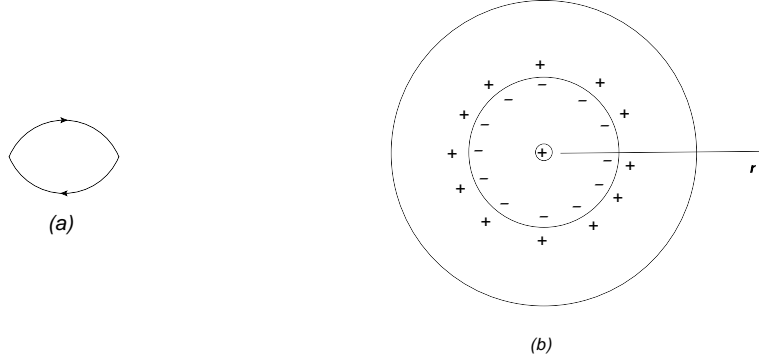

Figure 22: (a) Electron-positron creation and annihilation; (b) Vacuum polarization

\implies Running coupling constant

♣ Renormalization group β -function $\beta(g)$

gives us an information how the running coupling constant behaves with change of the energy-momentum scale at which the coupling constant is renormalized

$$\frac{d\bar{g}(t)}{dt} = \beta(\bar{g}), \quad t = \log(\mu/\mu_0) \quad \text{with } \bar{g}(0) = g \quad (259)$$

$$\text{Solution} \quad t = \int_g^{\bar{g}(t)} \frac{dg'}{\beta(g')} \quad (260)$$

• QED β function in the leading order

$$\frac{d\bar{e}(t)}{dt} = \beta(\bar{e}), \quad \text{with } \beta(\bar{e}) = \frac{1}{12\pi^2} \bar{e}^3 \quad (261)$$

$$\text{Solution} \quad \bar{e}^2(t) = \frac{e^2}{1 - \frac{e^2}{6\pi^2} t} \quad (262)$$

With the replacements: $t = \frac{1}{2} \log \frac{-q^2}{\Lambda m^2}$; $\bar{e}^2(t) = 4\pi\alpha_{\text{eff}}(q^2)$; $e^2 = 4\pi\alpha$, the solution (262) leads to the expression of $\alpha_{\text{eff}}(q^2)$

♣ Behaviors of β function

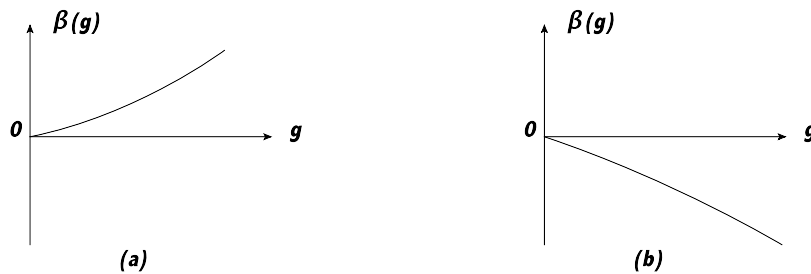

Figure 23: $\beta(\bar{g})$ is a monotonically (a) increasing or (b) decreasing function of \bar{g} .

- (a) If $\beta(\bar{g})$ has no zero except at $\bar{g} = 0$ and is positive as shown in Fig.23(a),
 $\bar{g}(t)$ behaves as $\bar{g}(t) \longrightarrow \text{large}$ for $t \longrightarrow \text{large}$ (QED)
- (b) If $\beta(\bar{g})$ has no zero except at $\bar{g} = 0$ and is negative as shown in Fig.23(b),

$$\bar{g}(t) \text{ behaves as } \begin{cases} \bar{g}(t) \rightarrow 0, & \text{for } t \rightarrow \infty; & \text{(Asymptotic freedom)} \\ \bar{g}(t) \rightarrow \infty, & \text{for } t \rightarrow -\infty; & \text{(Quark confinement)} \end{cases}$$

- [Question] Predict the behavior of the effective coupling constant \bar{g} as $t \rightarrow \infty$, when $\beta(\bar{g})$ is described as shown in Fig.24(c) and (d).

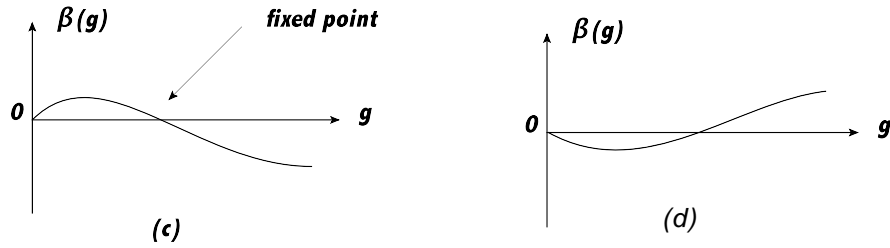

Figure 24: Other examples of the form of $\beta(\bar{g})$.

4.2 How to calculate β function in $\overline{\text{MS}}$ scheme

We start with the relation

$$g_{\text{bare}} = Z_g g_R \mu^\epsilon \quad (263)$$

between the bare coupling constant and the renormalized one. μ is a mass parameter which is introduced in dimensional regularization and is called as “renormalization scale”. Examples of the above relations are

$$e_0 = Z_2^{-1} Z_3^{-1/2} Z_1 e \mu^\epsilon = Z_3^{-1/2} e \mu^\epsilon, \quad (\text{QED}) \quad (264)$$

$$g_0 = Z_2^{-1} Z_3^{-1/2} Z_1 g \mu^\epsilon = Z_3^{-3/2} Z_1^3 g \mu^\epsilon = \dots, \quad (\text{QCD}) \quad (265)$$

- We apply $\mu \frac{d}{d\mu}$ to both sides of Eq.(263). The bare coupling constant g_{bare} does not depend on μ . The μ dependence of the renormalization constant Z_g comes through g_R . Thus we see $\frac{dZ_g}{d\mu} = \frac{dg_R}{d\mu} \frac{dZ_g}{dg_R}$.

$$\begin{aligned} 0 &= \mu \frac{dg_{\text{bare}}}{d\mu} \\ &= \mu^\epsilon \left[\mu \frac{dg_R}{d\mu} \left(\frac{dZ_g}{dg_R} g_R + Z_g \right) + \epsilon Z_g g_R \right] \end{aligned} \quad (266)$$

- Z_g is expressed as

$$Z_g = 1 + \frac{a_1}{\epsilon} + \frac{a_2}{\epsilon^2} + \dots = 1 + \sum_{i=1} \frac{a_i}{\epsilon^i} \quad (267)$$

and a_i 's are functions of g_R . We write $\frac{da_i}{dg_R}$ as $a'_i \equiv \frac{da_i}{dg_R}$. The function $\mu \frac{dg_R}{d\mu}$ is regular in ϵ and any singular term like $\frac{1}{\epsilon}$ does not appear. Thus $\mu \frac{dg_R}{d\mu}$ is expressed as

$$\mu \frac{dg_R}{d\mu} = d_0 + \epsilon d_1 + \sum_{i=2} \epsilon^i d_i \quad (268)$$

Plugging Eqs.(267) and (268) into (266), we get

$$0 = \left(d_0 + \epsilon d_1 + \sum_{i=2} \epsilon^i d_i \right) \left(g_R \sum_{i=1} \frac{a'_i}{\epsilon^i} + 1 + \sum_{i=1} \frac{a_i}{\epsilon^i} \right) + \epsilon g_R \left(1 + \sum_{i=1} \frac{a_i}{\epsilon^i} \right) \quad (269)$$

- The coefficients of ϵ^i ($i \geq 2$) should be zero $\rightarrow d_i = 0$ for $i \geq 2$
- The coefficients of ϵ should be zero $\rightarrow d_1 = -g_R$

Now the above equation reduces to

$$0 = d_0 \left(g_R \sum_{i=1} \frac{a'_i}{\epsilon^i} + 1 + \sum_{i=1} \frac{a_i}{\epsilon^i} \right) - g_R^2 \left(a'_1 + \sum_{i=1} \frac{a_{i+1}}{\epsilon^i} \right) \quad (270)$$

Then we obtain

$$d_0 = g_R^2 a'_1 \quad (271)$$

$$a'_{i+1} = a'_1 (g_R a'_i + a_i) \quad \text{for } i \geq 1 \quad (272)$$

- Taking the limit $\epsilon \rightarrow 0$, we obtain

$$\beta(g_R) \equiv \mu \frac{dg_R}{d\mu} \Big|_{\epsilon \rightarrow 0} = d_0 = g_R^2 a'_1 \Big|_{\epsilon \rightarrow 0} \quad (273)$$

4.2.1 Calculation of β function in leading order in QED

From Eqs.(264) and (69), $Z_{g(\text{QED})}$ in leading order is written as

$$Z_{g(\text{QED})} = Z_3^{-1/2} = 1 - \frac{1}{2} Z_3^{(1)}(\alpha) = 1 + \frac{1}{\epsilon} \frac{e^2}{16\pi^2} S^\epsilon \frac{2}{3} \quad (274)$$

We get $a'_1 \Big|_{\epsilon \rightarrow 0} = \frac{e}{12\pi^2}$, and thus we obtain in leading order

$$\beta(e) = \frac{e^3}{12\pi^2}$$

4.3 Running coupling constant in QCD

♣ Calculation of β function in leading order in QCD

From Eqs.(265), (151) and (254), $Z_{g(\text{QCD})}$ in leading order is written as

$$\begin{aligned}
Z_{g(\text{QCD})} &= Z_3^{-3/2} Z_1^{3g} = \left(1 - \frac{3}{2} Z_3^{(1)}(\alpha_s)\right) \left(1 + Z_1^{3g(1)}(\alpha_s)\right) \\
&= 1 - \frac{3}{2} Z_3^{(1)}(\alpha_s) + Z_1^{3g(1)}(\alpha_s) + \dots \\
&= 1 + \frac{1}{\epsilon} \frac{g^2}{16\pi^2} S^\epsilon \left[\left(\frac{2}{3} C_G - \frac{4}{3} n_f T_R\right) - \frac{3}{2} \left(\frac{5}{3} C_G - \frac{4}{3} n_f T_R\right) \right] + \dots \\
&= 1 + \frac{1}{\epsilon} \frac{g^2}{16\pi^2} S^\epsilon \left[-\frac{11}{6} C_G + \frac{2}{3} n_f T_R \right] + \dots
\end{aligned} \tag{275}$$

We get $a'_1|_{\epsilon \rightarrow 0} = \frac{2g}{16\pi^2} \left[-\frac{11}{6} C_G + \frac{2}{3} n_f T_R \right]$, and thus we obtain in leading order

$$\beta(g) = -\frac{g^3}{16\pi^2} \beta_0 \quad \text{with} \quad \beta_0 = \left[\frac{11}{3} C_G - \frac{4}{3} n_f T_R \right] \tag{276}$$

Since $\beta_0 > 0$ for $n_f < 33/2$, the behavior of the β function in QCD corresponds to the one in Fig.23(b).

QCD is a theory with the property of asymptotic freedom.

♣ Effective running coupling of QCD in leading order

$$\frac{d\bar{g}}{dt} = \beta(\bar{g}) = -\beta_0 \frac{\bar{g}^3}{16\pi^2} \tag{277}$$

From Eq.(260), we find that the solution is written as

$$\bar{g}(t)^2 = \frac{g^2}{1 + 2\beta_0(g^2/16\pi^2)t} \tag{278}$$

$$\longrightarrow 0 \quad \text{as} \quad t \longrightarrow \infty$$

Putting $2t \rightarrow \log \frac{Q^2}{\mu^2}$, we express the QCD running coupling constant as

$$\frac{\alpha_s(Q^2)}{4\pi} = \frac{\alpha_s(\mu^2)/(4\pi)}{1 + \beta_0 \frac{1}{4\pi} \log \frac{Q^2}{\mu^2}} = \frac{1}{\beta_0 \log \frac{Q^2}{\Lambda^2}} \tag{279}$$

where $\Lambda^2 = \mu^2 \exp\left[-\frac{4\pi}{\beta_0 \alpha_s(\mu^2)}\right]$. Experimentally, $\Lambda_{\overline{\text{MS}}}$ is chosen to be 0.2 - 0.3 GeV.

5 Deep Inelastic Scattering (DIS)

DIS : prototype for hard processes in QCD

A high energy lepton (electron, muon or neutrino) scatters off a target nucleon, transferring *large* quantities of both *energy* and *invariant squared-four-momentum*.

5.1 Deep inelastic electron-nucleon scattering

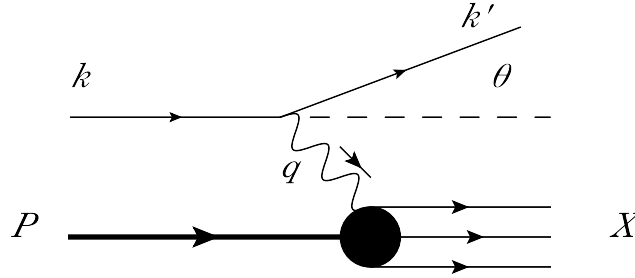

Figure 25: Kinematics of electron-nucleon scattering in the target rest frame

- *Deep inelastic region*, where $Q^2 = -q^2$ and $w = P \cdot q$ are large

$$\begin{aligned}
 q^2 &\equiv (k - k')^2 = q_0^2 - \vec{q}^2 = -4EE' \sin^2(\theta/2) = -Q^2 \\
 w &\equiv P \cdot q = M(E - E') \\
 x &\equiv \frac{Q^2}{2P \cdot q} \quad (\text{Bjorken variable}) \\
 y &\equiv \frac{P \cdot q}{P \cdot k} = \frac{E - E'}{E},
 \end{aligned} \tag{280}$$

$$(P + q)^2 \geq M^2 \Rightarrow 0 \leq x \leq 1, \quad 0 \leq y \leq 1$$

- In the parton model, x is the fraction of the nucleon's momentum carried by the struck quark.
- y is the fraction of the electron energy lost in the nucleon rest frame.
- The differential cross-section for the unpolarized inclusive scattering ($eN \rightarrow e'X$) (We neglect electron mass; $m_e = 0$)

$$\begin{aligned}
 d\sigma &= \frac{1}{\text{Flux}} \frac{d^3k'}{(2\pi)^3 2E'} \frac{1}{4} \sum_{s_e, s'_e, \lambda} \sum_X \Pi_{i=1}^{n_X} \int \frac{d^3p_i}{(2\pi)^3 2p_{i0}} (2\pi)^4 \delta^4(P + q - \sum_{i=1}^{n_X} p_i) \\
 &\quad \times |\langle e'X | T | eN \rangle|^2
 \end{aligned} \tag{281}$$

where

$$\langle e'X|T|eN\rangle = \bar{u}(k', s'_e) e \gamma_\mu u(k, s_e) \frac{1}{q^2} \langle X|eJ^\mu(0)|P, \lambda\rangle \quad (282)$$

where s'_e , s_e and λ are spin components of the scattered electron, initial electron and target nucleon, respectively.

$$\begin{aligned} \text{Flux} &= 4k \cdot P (= 4ME \quad \text{in the nucleon rest frame}) \\ \sum_{i=1}^{n_X} p_i &\equiv p_X, \quad \sum_X \prod_{i=1}^{n_X} \int \frac{d^3 p_i}{(2\pi)^3 2p_{i0}} \Rightarrow \sum_X \\ \frac{1}{4\pi} \frac{1}{4} \sum_{s_e, s'_e, \lambda} \sum_X (2\pi)^4 \delta^4(P + q - p_X) |\langle e'X|T|eN\rangle|^2 &\equiv \frac{(4\pi\alpha)^2}{Q^4} l^{\mu\nu} W_{\mu\nu} \end{aligned} \quad (283)$$

- The leptonic tensor

$$\begin{aligned} l^{\mu\nu} &= \frac{1}{2} \sum_{s_e, s'_e} \bar{u}(k, s_e) \gamma^\mu u(k', s'_e) \bar{u}(k', s'_e) \gamma^\nu u(k, s_e) \\ &= 2(k^\mu k'^\nu + k'^\mu k^\nu) - 2g^{\mu\nu} k \cdot k' \end{aligned} \quad (284)$$

- The hadronic tensor and nucleon structure functions F_1 and F_2

$$\begin{aligned} W^{\mu\nu} &= \frac{1}{4\pi} \sum_X (2\pi)^4 \delta^4(P + q - p_X) \frac{1}{2} \sum_\lambda \langle P, \lambda | J^\mu | X \rangle \langle X | J^\nu | P, \lambda \rangle \\ &= \left(-g^{\mu\nu} + \frac{q^\mu q^\nu}{q^2} \right) F_1 + \left[\left(P^\mu - \frac{P \cdot q}{q^2} q^\mu \right) \left(P^\nu - \frac{P \cdot q}{q^2} q^\nu \right) \right] \frac{F_2}{P \cdot q} \end{aligned} \quad (285)$$

where F_1 and F_2 are functions of w and Q^2 , or, equivalently, of $x = \frac{Q^2}{2w}$ and Q^2 . Note that $q_\mu W^{\mu\nu} = 0$, since J^μ is the conserved current so that we have $\partial_\mu J^\mu = 0$.

- Since

$$l^{\mu\nu} W_{\mu\nu} = \frac{4Q^2}{y} \left\{ \frac{y}{2} F_1 + \frac{1}{2xy} \left(1 - y - \frac{x^2 y^2 M^2}{Q^2} \right) F_2 \right\} \quad (286)$$

we obtain for the cross section for unpolarized electron-nucleon scattering

$$\frac{d^2\sigma}{dxdy} = \frac{8\pi\alpha^2}{Q^2} \left\{ \frac{y}{2} F_1(x, Q^2) + \frac{1}{2xy} \left(1 - y - \frac{x^2 y^2 M^2}{Q^2} \right) F_2(x, Q^2) \right\} \quad (287)$$

- [Problem] Show the following relation

$$\frac{1}{4ME} \frac{d^3 k'}{(2\pi)^3 2E'} = \frac{1}{(2\pi)^2} \frac{y}{8} dxdy \quad (288)$$

and derive Eq.(287).

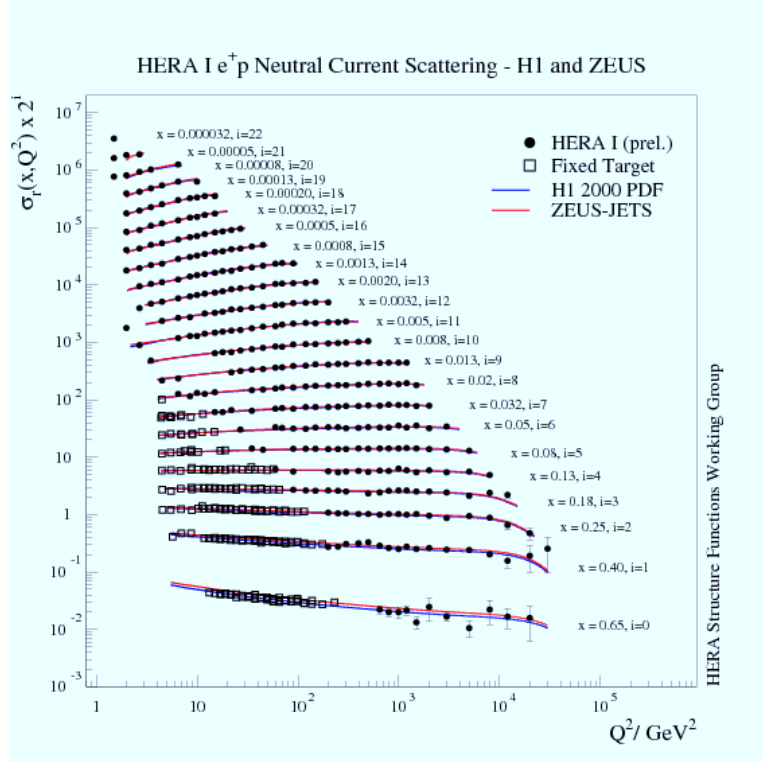

Figure 26: High Q^2 Structure Functions at HERA: H1 and ZEUS Collaboration, arXiv:0806.2615 [hep-ex]

5.2 Scaling

The SLAC-MIT experimental data and the HERA data (see Fig.26) show that for $Q^2 > 1\text{GeV}^2$, the structure functions depend very weakly on Q^2 .

- The state normalization convention: covariantly normalized

$$\langle P|P' \rangle = 2E(2\pi)^3 \delta^3(P - P') \quad (289)$$

- So $W^{\mu\nu}$ is dimensionless $\implies F_1, F_2$ are dimensionless
- Under a scale transformation, $p_i \rightarrow \lambda p_i$, $m_i \rightarrow \lambda m_i$, a theory becomes scale invariant in a limit in which all masses are negligible (but \dots).
- But if it is a renormalizable theory, a mass scale μ (renormalization scale) necessarily appears, and thus the scale invariance is broken by logarithms of p_i^2/μ^2 .
- In the Bjorken limit

$$Q^2 \longrightarrow \infty \quad w = P \cdot q \longrightarrow \infty \quad \text{with} \quad x = \frac{Q^2}{2P \cdot q} \text{ fixed} \quad (290)$$

QCD becomes scale invariant up to logarithms of Q^2 .

- QCD predicts that, in the Bjorken limit, the dimensionless structure functions F_1, F_2 are expressed as

$$F_1(Q^2, w) \longrightarrow F_1(x, \ln \frac{Q^2}{\Lambda^2}), \quad F_2(Q^2, w) \longrightarrow F_2(x, \ln \frac{Q^2}{\Lambda^2}), \quad (291)$$

5.3 Parton model

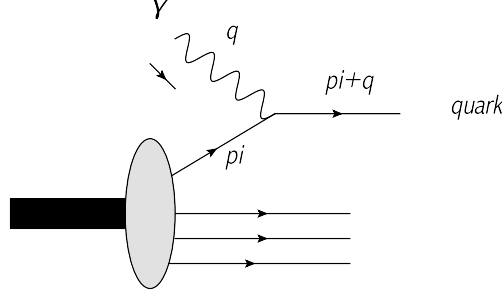

Figure 27: Deep inelastic electron-nucleon scattering in the parton model.

Bjorken and Feynman proposed a simple idea to explain the scaling behavior of the structure functions.

- The proton is a loosely bound collection of quarks (and antiquarks) and gluons, which are called generically as *partons*.
- These partons are assumed to be incapable of exchange large momenta q^2 through the strong interactions.
- The proton contains a quark-parton of type i and longitudinal fraction ξ with the probability $f_i(\xi)$. Parton masses are assumed to be small and are neglected.
- The momentum of parton i is expressed as $p_i = \xi P$.
- The quark-parton is hit by electron and knocked out of the proton gaining large momentum q . The scattered parton is also assumed to be massless and we get

$$0 \approx (p_i + q)^2 = 2p_i \cdot q + q^2 = 2\xi P \cdot q - Q^2 \quad (292)$$

which leads to $\xi = \frac{Q^2}{2P \cdot q} = x$.

- Thus, in the parton model, the structure function F_2 is expressed as

$$\frac{1}{x} F_2(x) = \sum_i \int_0^1 d\xi f_i(\xi) e_i^2 \delta(\xi - x) = \sum_i e_i^2 f_i(x) \quad (293)$$

where e_i is the electric charge of the quark-parton i . Here i stands for $u, \bar{u}, d, \bar{d}, s, \bar{s}$, and \dots .

6 Application of perturbative QCD to DIS

6.1 DGLAP equations

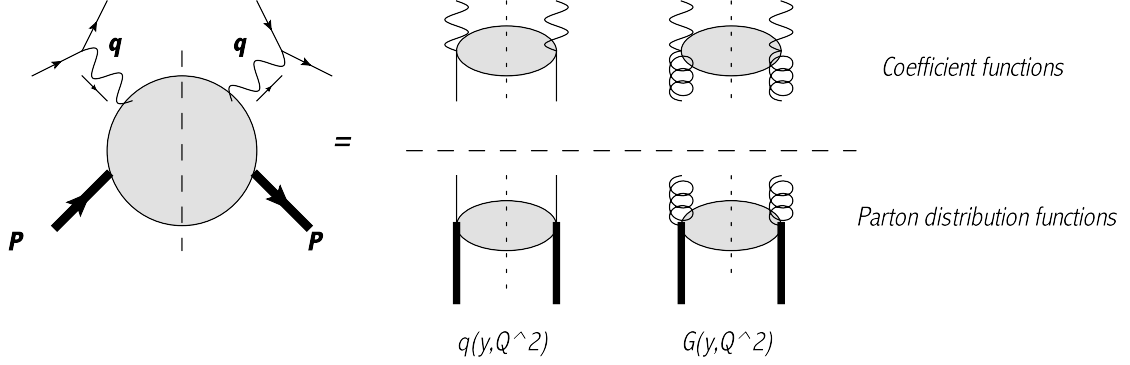

Figure 28: Factorization in DIS: Momentum of order q^2 flows in the upper parts corresponding to *coefficient functions*. Lower parts are described by *parton distribution functions of nucleon*.

♠ In the QCD improved parton model, which is based on the factorization theorem (see Fig.28), the nucleon structure function $F_2(x, Q^2)$ is expressed as

$$\frac{1}{x} F_2(x, Q^2) = \int_x^1 \frac{dy}{y} \left\{ \sum_{i=1}^{2n_f} q^i(y, Q^2) C_2^i\left(\frac{x}{y}, \alpha_s(Q^2)\right) + G(y, Q^2) C_2^G\left(\frac{x}{y}, \alpha_s(Q^2)\right) \right\}, \quad (294)$$

where C_2^i and C_2^G are the coefficient functions corresponding to i -quark and gluon, respectively. They are independent of the properties of the target nucleon. $q^i(y, Q^2)$ and $G(y, Q^2)$ are parton distribution functions of nucleon.

- The parton distribution function $q^i(x, Q^2)$ is the number density of quarks of type i (we distinguish between quark and anti-quark) inside a proton at the scale Q^2 with fraction of x of the proton longitudinal momentum in the P_∞ frame. $G(x, Q^2)$ is the number density of gluons inside the proton at the scale Q^2 in the P_∞ frame.
- QCD can predict how the parton distribution functions, $q^i(y, Q^2)$ and $G(y, Q^2)$, change with the scale Q^2 . They follow the integro-differential equations called as the DGLAP evolution equations:

$$\frac{dq^i(x, Q^2)}{d \ln Q^2} = \int_x^1 \frac{dy}{y} \left\{ \sum_{j=1}^{2n_f} P_{q^i q^j}\left(\frac{x}{y}, Q^2\right) q^j(y, Q^2) + P_{q^i G}\left(\frac{x}{y}, Q^2\right) G(y, Q^2) \right\}, \quad (295)$$

$$\frac{dG(x, Q^2)}{d\ln Q^2} = \int_x^1 \frac{dy}{y} \left\{ \sum_{j=1}^{2n_f} P_{Gq^j} \left(\frac{x}{y}, Q^2 \right) q^j(y, Q^2) + P_{GG} \left(\frac{x}{y}, Q^2 \right) G(y, Q^2) \right\}, \quad (296)$$

where P_{AB} is a splitting function of B -parton to A -parton.

- The quark-quark splitting function $P_{q^i q^j}$ is made up of two pieces: the one representing the case that j -quark splits into i -quark without through gluon, and the other one through gluon,

$$P_{q^i q^j} = \delta_{ij} P_{qq} + \frac{1}{2n_f} P_{qq}^S \quad (297)$$

where the second term is representing the splitting through gluon, and P_{qq} and P_{qq}^S are both independent of the flavor, i and j . P_{qq}^S first appears in the order of α_s^2 .

- When we neglect all quark masses, the probability of emitting a gluon is the same for all flavors: $\Rightarrow P_{Gq^i} = P_{Gq}$ (independent of i)
- A gluon creates a massless quark-antiquark pair with equal probability for all flavors: $\Rightarrow P_{q^i G} = P_{qG}$ (independent of i)
- For later convenience we use, instead of q^i , the flavor singlet and non-singlet quark distribution functions defined as follows:

$$q_S \equiv \sum_{i=1}^{2n_f} q^i, \quad q_{NS}^i \equiv q^i - \frac{q_S}{2n_f}, \quad (298)$$

so that $\sum_i q_{NS}^i = 0$.

Then the evolution equations for q_S , G and q_{NS}^i are written as

$$\begin{aligned} \frac{dq_S(x, Q^2)}{d\ln Q^2} = \int_x^1 \frac{dy}{y} \left\{ \left(P_{qq} \left(\frac{x}{y}, Q^2 \right) + P_{qq}^S \left(\frac{x}{y}, Q^2 \right) \right) q_S(y, Q^2) \right. \\ \left. + 2n_f P_{qG} \left(\frac{x}{y}, Q^2 \right) G(y, Q^2) \right\}, \end{aligned} \quad (299)$$

$$\frac{dG(x, Q^2)}{d\ln Q^2} = \int_x^1 \frac{dy}{y} \left\{ P_{Gq} \left(\frac{x}{y}, Q^2 \right) q_S(y, Q^2) + P_{GG} \left(\frac{x}{y}, Q^2 \right) G(y, Q^2) \right\}, \quad (300)$$

$$\frac{dq_{NS}^i(x, Q^2)}{d\ln Q^2} = \int_x^1 \frac{dy}{y} P_{qq} \left(\frac{x}{y}, Q^2 \right) q_{NS}^i(y, Q^2) \quad (301)$$

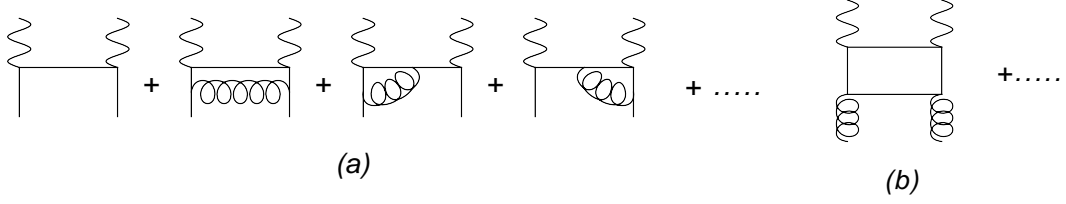

Figure 29: Coefficient functions up to one-loop level: (a) quark C_2^i ; (b) gluon C_2^G .

- The coefficient functions C_2^i and C_2^G are obtained in perturbative QCD by evaluating the diagrams shown in Fig.29. Up to one-loop level they are given by,

$$C_2^i(z, \alpha_s(Q^2)) = e_i^2 \left\{ \delta(1-z) + \frac{\alpha_s(Q^2)}{4\pi} B_q(z) \right\} \quad (302)$$

$$C_2^G(z, \alpha_s(Q^2)) = \langle e^2 \rangle \left\{ 0 + \frac{\alpha_s(Q^2)}{4\pi} B_G(z) \right\} \quad (303)$$

where $\langle e^2 \rangle = \sum_i e_i^2 / 2n_f$. It is noted that $B_q(z)$ in Eq.(302) is independent of the quark flavor i .

- Since $\sum_i q^i C_2^i$ is rewritten as

$$\begin{aligned} \sum_{i=1}^{2n_f} q^i C_2^i &= \sum_{i=1}^{2n_f} \left\{ q_{NS}^i + \frac{q_S}{2n_f} \right\} C_2^i \\ &= q(y, Q^2) \langle e^2 \rangle \left\{ \left(1 - \frac{x}{y}\right) + \frac{\alpha_s(Q^2)}{4\pi} B_q\left(\frac{x}{y}\right) \right\} \\ &\quad + \sum_{i=1}^{2n_f} e_i^2 q_{NS}^i(y, Q^2) \left\{ \left(1 - \frac{x}{y}\right) + \frac{\alpha_s(Q^2)}{4\pi} B_q\left(\frac{x}{y}\right) \right\}, \end{aligned} \quad (304)$$

we obtain

$$\begin{aligned} \frac{1}{x} F_2^\gamma(x, Q^2, P^2) &= \int_x^1 \frac{dy}{y} \left\{ q_S(y, Q^2) C_2^S\left(\frac{x}{y}, \alpha_s(Q^2)\right) + G(y, Q^2) C_2^G\left(\frac{x}{y}, \alpha_s(Q^2)\right) \right. \\ &\quad \left. + q_{NS}(y, Q^2) C_2^{NS}\left(\frac{x}{y}, \alpha_s(Q^2)\right) \right\} \end{aligned} \quad (305)$$

where we have defined

$$C_2^S(z, \alpha_s(Q^2)) \equiv \langle e^2 \rangle \left\{ \delta(1-z) + \frac{\alpha_s(Q^2)}{4\pi} B_S(z) \right\} \quad (306)$$

$$C_2^{NS}(z, \alpha_s(Q^2)) \equiv \delta(1-z) + \frac{\alpha_s(Q^2)}{4\pi} B_{NS}(z) \quad (307)$$

$$q_{NS} \equiv \sum_{i=1}^{2n_f} e_i^2 q_{NS}^i \quad (308)$$

and $B_S(z) = B_{NS}(z) = B_q(z)$.

From Eq.(301) and (308), the evolution equation for q_{NS} is given by

$$\frac{dq_{NS}(x, Q^2)}{d\ln Q^2} = \int_x^1 \frac{dy}{y} P_{qq}\left(\frac{x}{y}, Q^2\right) q_{NS}(y, Q^2) \quad (309)$$

6.2 Splitting functions P_{AB} in the leading order

Splitting functions $P_{AB}(z, Q^2)$ are expanded in powers of the QCD coupling constant as

$$P_{AB}(z, Q^2) = \frac{\alpha_s(Q^2)}{2\pi} P_{AB}^{(0)}(z) + \left[\frac{\alpha_s(Q^2)}{2\pi} \right]^2 P_{AB}^{(1)}(z) + \dots, \quad (310)$$

- In the leading order, $P_{AB}^{(0)}(z)$ is obtained by

$$P_{AB}^{(0)}(z) = \frac{1}{2} z(1-z) \sum_{\text{spin}} \frac{|V_{B \rightarrow A+C}|^2}{p_{\perp}^2} \quad (z < 1) \quad (311)$$

Ref. G. Altarelli and G. Parisi, Nucl. Phys. B126 (1977) 298.

Ref. Peskin and Schroeder: Chapter 17.5

$$P_{qq}^{(0)}(z) = \frac{4}{3} \frac{1+z^2}{(1-z)_+} + 2\delta(1-z) \quad (312)$$

$$P_{Gq}^{(0)}(z) = \frac{4}{3} \frac{1+(1-z)^2}{z} \quad (313)$$

$$2n_f P_{qG}^{(0)}(z) = n_f [z^2 + (1-z)^2] \quad (314)$$

$$P_{GG}^{(0)}(z) = 6 \left[\frac{1-z}{z} + \frac{z}{(1-z)_+} + z(1-z) \right] + \left(\frac{11}{2} - \frac{1}{3} n_f \right) \delta(1-z) \quad (315)$$

where

$$\int_0^1 dz \frac{f(z)}{(1-z)_+} \equiv \int_0^1 dz \frac{f(z) - f(1)}{1-z} \quad (316)$$

- Some properties of splitting functions $P_{AB}^{(0)}(z)$

- For $z < 1$, from momentum conservation

$$P_{qq}^{(0)}(z) = P_{Gq}^{(0)}(1-z)$$

$$P_{qG}^{(0)}(z) = P_{qG}^{(0)}(1-z)$$

$$P_{GG}^{(0)}(z) = P_{GG}^{(0)}(1-z)$$

- Since the physical meaning of the evolution equation

$$q(x, Q^2) + \Delta q(x, Q^2) = \int_0^1 dy \int_0^1 dz q(y, Q^2) \mathcal{P}_{qq}(z, Q^2) \delta(x - yz)$$

$$\mathcal{P}_{qq}(z, Q^2) = \delta(1 - z) + \frac{\alpha_s(Q^2)}{2\pi} P_{qq}^{(0)}(z) \ln \frac{Q^2}{\mu^2}$$

$\mathcal{P}_{qq}(z, Q^2)$ is a probability density up to α_s .

$$\int_0^1 dz \mathcal{P}_{qq}(z, Q^2) = 1 \quad \Rightarrow \quad \int_0^1 dz P_{qq}^{(0)}(z) = 0 \quad (317)$$

- Conservation of energy-momentum tensor

$$\int_0^1 dx x (q_S(x, Q^2) + G(x, Q^2)) = 1 \quad (\text{independent of } Q^2)$$

$$\int_0^1 dx x \left\{ \frac{dq_S(x, Q^2)}{d \ln Q^2} + \frac{dG(x, Q^2)}{d \ln Q^2} \right\} = 0$$

\Rightarrow

$$\int_0^1 dz z [P_{qq}^{(0)}(z) + P_{Gq}^{(0)}(z)] = 0$$

$$\int_0^1 dz z [2n_f P_{qG}^{(0)}(z) + P_{GG}^{(0)}(z)] = 0$$

7 LHC

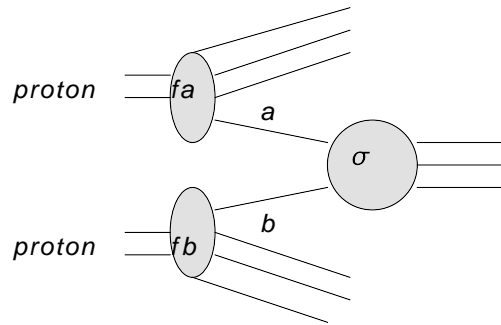

Figure 30: The hard process in pp collision

Perturbative QCD is applicable to the hard processes where the transfer of large momentum occurs. The hard process in a proton-proton collider such as LHC is depicted

as in Fig.30 and its cross section is expressed as

$$d\sigma^{pp \rightarrow \hat{\sigma}+X} \approx \sum_{a,b} f_a(x_1, \mu) \otimes f_b(x_2, \mu) \otimes d\hat{\sigma}(x_1, x_2, \hat{s}, \mu) \quad (318)$$

where $f_a(x_1, \mu)$ ($f_b(x_2, \mu)$) is the distribution function of a (b) parton (u -quark, u -antiquark, \dots , and gluon) of the parent proton and μ is the factorization scale.

The parton distribution functions (PDF), which are universal and do not depend on specific reactions, are now obtained from <http://www.hepforge.org> by downloading the package of LHAPDF. The part $d\hat{\sigma}(x_1, x_2, \hat{s}, \mu)$ is calculated by using perturbative QCD.

- Higgs production in pp collisions

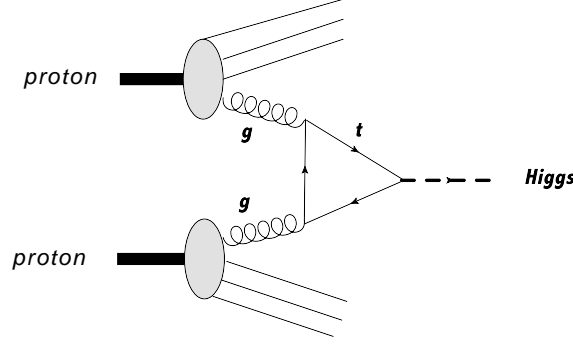

Figure 31: Higgs production in pp collisions through the gluon fusion diagram.

$$d\sigma^{pp \rightarrow H+X} \approx \sum_g f_g(x_1, \mu) \otimes f_g(x_2, \mu) \otimes d\hat{\sigma}^{gg \rightarrow H}(x_1, x_2, m_H, \mu) \quad (319)$$

- Drell-Yan process

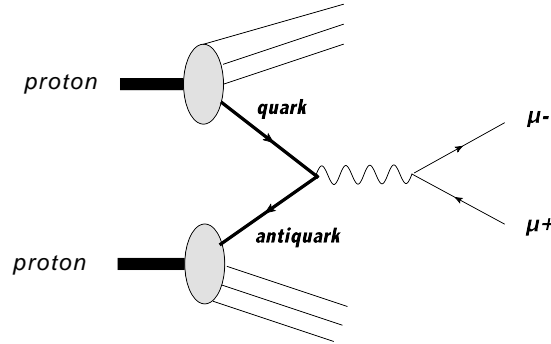

Figure 32: The Drell-Yan process in pp collisions.

$$d\sigma^{pp \rightarrow \mu^+ \mu^- + X} \approx \sum_{a, \bar{a}} f_a(x_1, \mu) \otimes f_{\bar{a}}(x_2, \mu) \otimes d\hat{\sigma}^{a\bar{a} \rightarrow \mu^+ \mu^-}(x_1, x_2, Q, \mu) \quad (320)$$

A Notations and Conventions

- We work in natural units, where $c = \hbar = 1$.
- Relativity

$$g_{\mu\nu} = g^{\mu\nu} = \begin{pmatrix} 1 & 0 & 0 & 0 \\ 0 & -1 & 0 & 0 \\ 0 & 0 & -1 & 0 \\ 0 & 0 & 0 & -1 \end{pmatrix} \quad (321)$$

$$\begin{aligned} x^\mu &= (t, \mathbf{r}), & x_\mu &= g_{\mu\nu}x^\nu = (t, -\mathbf{r}) \\ p^\mu &= (E, \mathbf{p}), & p_\mu &= g_{\mu\nu}p^\nu = (E, -\mathbf{p}) \\ \partial^\mu &= \frac{\partial}{\partial x_\mu} = \left(\frac{\partial}{\partial t}, -\nabla\right), & \partial_\mu &= \frac{\partial}{\partial x^\mu} = \left(\frac{\partial}{\partial t}, \nabla\right) \end{aligned} \quad (322)$$

B Scalar One-loop Integrals

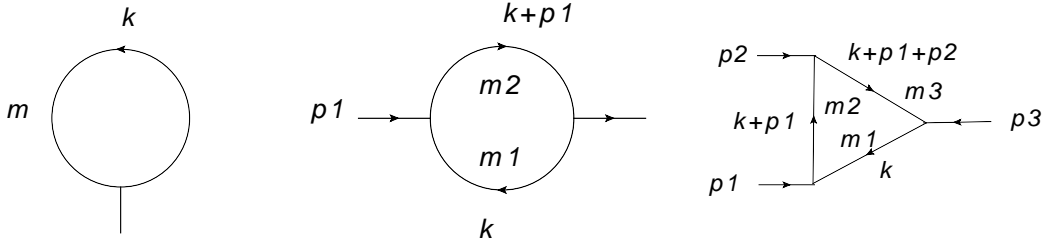

Figure 33: (a) One-point integral ; (b) Two-point integral; (c) Three-point integral.

The scalar one-loop integrals which appeared in Section 2.6 are the one-, two- and three-point integrals which are defined as (see Fig.33),

$$A_0(m^2) \equiv \frac{(2\pi\mu)^{4-n}}{i\pi^2} \int \frac{d^n k}{[k^2 - m^2]}, \quad (323)$$

$$B_0(p^2; m_1^2, m_2^2) \equiv \frac{(2\pi\mu)^{4-n}}{i\pi^2} \int \frac{d^n k}{[k^2 - m_1^2][(k+p)^2 - m_2^2]}, \quad (324)$$

$$\begin{aligned} C_0(p_1^2, p_2^2, p_3^2; m_1^2, m_2^2, m_3^2) \\ \equiv \frac{(2\pi\mu)^{4-n}}{i\pi^2} \int \frac{d^n k}{[k^2 - m_1^2][(k+p_1)^2 - m_2^2][(k+p_1+p_2)^2 - m_3^2]}, \end{aligned} \quad (325)$$

where $n = 4 - 2\epsilon$ and μ is the mass scale of dimensional regularization. Note that $p_1 + p_2 + p_3 = 0$ for the three-point integrals C_0 .

B.1 One-point integral

$$\begin{aligned}
A_0(m^2) &\equiv \frac{(2\pi\mu)^{4-n}}{i\pi^2} \int \frac{d^n k}{k^2 - m^2} \\
&= \left(\frac{4\pi\mu^2}{m^2}\right)^\epsilon e^{-\epsilon\gamma_E} \times m^2 \left(\frac{1}{\epsilon} + 1 + \mathcal{O}(\epsilon)\right)
\end{aligned} \tag{326}$$

$A_0(m^2)$ is related to the two-point integral $B_0(0; m^2, m^2)$ as follows:

$$A_0(m^2) = B_0(0; m^2, m^2) m^2 + m^2 \tag{327}$$

B.2 Two-point integrals

B.2.1 General two-point integrals with different masses

$$\begin{aligned}
B_0(p^2; m_1^2, m_2^2) &\equiv \frac{(2\pi\mu)^{4-n}}{i\pi^2} \int \frac{d^n k}{[k^2 - m_1^2][(k+p)^2 - m_2^2]} \\
&= (4\pi\mu^2)^\epsilon e^{-\epsilon\gamma_E} \times \int dx_1 dx_2 \delta(x_1 + x_2 - 1) \left(\frac{1}{\epsilon} - \log \mathcal{D} + \mathcal{O}(\epsilon)\right)
\end{aligned} \tag{328}$$

with $\mathcal{D} = m_1^2 x_1 + m_2^2 x_2 - p^2 x_1 x_2$.

- Interchanging the Feynman parameters, we obtain the following relation:

$$B_0(p^2; m_1^2, m_2^2) = B_0(p^2; m_2^2, m_1^2), \quad \text{by } (x_1 \leftrightarrow x_2) \tag{329}$$

B.2.2 Calculation of $\left.\frac{d}{dp^2} B_0(p^2; m^2, \lambda^2)\right|_{p^2=m^2}$

In general, two-point functions do not have infrared divergences, but their derivatives may have ones. Thus we have introduced a small photon mass λ^2 .

\mathcal{D} is written as $\mathcal{D} = m^2 x_1 + \lambda^2 x_2 - p^2 x_1 x_2$. We obtain

$$\begin{aligned}
\frac{d}{dp^2} B_0(p^2; m^2, \lambda^2) &= \int dx_1 dx_2 \delta(x_1 + x_2 - 1) \frac{x_1 x_2}{\mathcal{D}} \\
&= \int_0^1 dx_1 \frac{x_1(1-x_1)}{m^2 x_1 + \lambda^2(1-x_1) - p^2 x_1(1-x_1)}
\end{aligned} \tag{330}$$

Then we find

$$\begin{aligned}
\left.\frac{d}{dp^2} B_0(p^2; m^2, \lambda^2)\right|_{p^2=m^2} &= \int_0^1 dx_1 \frac{x_1(1-x_1)}{\lambda^2(1-x_1) + m^2 x_1^2} \\
&= \frac{1}{m^2} \left\{ -1 + \int_0^1 dx_1 \frac{(1 - \frac{\lambda^2}{m^2})x_1 + \frac{\lambda^2}{m^2}}{x_1^2 + \frac{\lambda^2}{m^2}(1-x_1)} \right\} \\
&\implies \frac{1}{m^2} \left\{ -1 - \frac{1}{2} \log \frac{\lambda^2}{m^2} \right\}
\end{aligned} \tag{331}$$

B.2.3 Special cases

1. $B_0(p^2, 0, 0)$ with $p^2 < 0$

Then \mathcal{D} is expressed as $\mathcal{D} = -p^2 x_1 x_2 = -p^2 x_1 (1 - x_1)$.

$$B_0(p^2, 0, 0) = \left(\frac{4\pi\mu^2}{-p^2}\right)^\epsilon e^{-\epsilon\gamma_E} \times \left(\frac{1}{\epsilon} + 2 + \mathcal{O}(\epsilon)\right) \quad (332)$$

2. $B_0(p^2; 0, m^2)$

Then \mathcal{D} is expressed as $\mathcal{D} = m^2 x_2 - p^2 x_1 x_2 = x_2 (m^2 - p^2 x_1)$.

- (a) For $p^2 = 0$;

$$B_0(0; 0, m^2) = \left(\frac{4\pi\mu^2}{m^2}\right)^\epsilon e^{-\epsilon\gamma_E} \times \left(\frac{1}{\epsilon} + 1 + \mathcal{O}(\epsilon)\right) \quad (333)$$

- (b) For $p^2 < m^2$;

Then $-\log \mathcal{D} = -\log x_2 - \log m^2 - \log(1 - ax_1)$ with $a \equiv \frac{p^2}{m^2} < 1$

$$\begin{aligned} & \int dx_1 dx_2 \delta(x_1 + x_2 - 1) (-\log \mathcal{D}) \\ &= \int_0^1 dx_2 (-\log x_2 - \log m^2) + \int_0^1 dx_1 \{-\log(1 - ax_1)\} \\ &= -\log m^2 + 1 + \left\{1 + \left(\frac{1}{a} - 1\right) \log(1 - a)\right\} \end{aligned} \quad (334)$$

Thus, for $p^2 < m^2$

$$B_0(p^2; 0, m^2) = \left(\frac{4\pi\mu^2}{m^2}\right)^\epsilon e^{-\epsilon\gamma_E} \times \left(\frac{1}{\epsilon} + 2 + \left(\frac{m^2}{p^2} - 1\right) \log\left(1 - \frac{p^2}{m^2}\right) + \mathcal{O}(\epsilon)\right) \quad (335)$$

- (c) For $p^2 > m^2$;

The analytic continuation: $\log\left(1 - \frac{p^2}{m^2} - i\epsilon\right) \rightarrow \log\left(\frac{p^2}{m^2} - 1\right) - i\pi$

$$B_0(p^2; 0, m^2) = \left(\frac{4\pi\mu^2}{m^2}\right)^\epsilon e^{-\epsilon\gamma_E} \times \left(\frac{1}{\epsilon} + 2 + \left(\frac{m^2}{p^2} - 1\right) \left\{\log\left(\frac{p^2}{m^2} - 1\right) - i\pi\right\} + \mathcal{O}(\epsilon)\right) \quad (336)$$

- (d) For $p^2 = m^2$;

$$B_0(m^2; 0, m^2) = \left(\frac{4\pi\mu^2}{m^2}\right)^\epsilon e^{-\epsilon\gamma_E} \times \left(\frac{1}{\epsilon} + 2 + \mathcal{O}(\epsilon)\right) \quad (337)$$

3. $B_0(p^2, m^2, m^2)$

Then \mathcal{D} is expressed as $\mathcal{D} = m^2 - p^2 x_2 (1 - x_2)$.

(a) For $p^2 = 0$;

$$B_0(0; m^2, m^2) = \left(\frac{4\pi\mu^2}{m^2}\right)^\epsilon e^{-\epsilon\gamma_E} \times \left(\frac{1}{\epsilon} + \mathcal{O}(\epsilon)\right) \quad (338)$$

(b) For $0 < p^2 < 4m^2$;

$$B_0(p^2; m^2, m^2) = \left(\frac{4\pi\mu^2}{m^2}\right)^\epsilon e^{-\epsilon\gamma_E} \times \left(\frac{1}{\epsilon} + 2 - 2\sqrt{\frac{4m^2}{p^2} - 1} \sin^{-1}\left(\sqrt{\frac{p^2}{4m^2}}\right) + \mathcal{O}(\epsilon)\right) \quad (339)$$

(c) For $p^2 < 0$;

$$B_0(p^2; m^2, m^2) = \left(\frac{4\pi\mu^2}{m^2}\right)^\epsilon e^{-\epsilon\gamma_E} \times \left(\frac{1}{\epsilon} + 2 - \sqrt{\frac{4m^2}{-p^2} + 1} \log\left(\frac{\sqrt{4m^2 - p^2} + \sqrt{-p^2}}{\sqrt{4m^2 - p^2} - \sqrt{-p^2}}\right) + \mathcal{O}(\epsilon)\right) \quad (340)$$

B.3 Three-point integrals

B.3.1 General three-point integrals with different masses

$C_0(p_1^2, p_2^2, (p_1 + p_2)^2; m_1^2, m_2^2, m_3^2)$, with $p_1 + p_2 + p_3 = 0$, is evaluated as

$$\begin{aligned} C_0(p_1^2, p_2^2, p_3^2; m_1^2, m_2^2, m_3^2) &\equiv \frac{(2\pi\mu)^{4-n}}{i\pi^2} \int \frac{d^n k}{[k^2 - m_1^2][(k + p_1)^2 - m_2^2][(k + p_1 + p_2)^2 - m_3^2]} \\ &= \frac{(2\pi\mu)^{4-n}}{i\pi^2} (2\pi)^n \frac{-i}{(4\pi)^{\frac{n}{2}}} \int dx_1 dx_2 dx_3 \delta(x_1 + x_2 + x_3 - 1) \Gamma(3) \times \frac{\Gamma(3 - \frac{n}{2})}{\Gamma(3)} \left(\frac{1}{\mathcal{D}}\right)^{3 - \frac{n}{2}} \\ &= - \int dx_1 dx_2 dx_3 \delta(x_1 + x_2 + x_3 - 1) \times \frac{1}{\mathcal{D}} \end{aligned} \quad (341)$$

with $\mathcal{D} = m_1^2 x_1 + m_2^2 x_2 + m_3^2 x_3 - p_1^2 x_1 x_2 - p_2^2 x_2 x_3 - p_3^2 x_3 x_1$.

- Interchanging the Feynman parameters, we obtain the following relations:

$$\begin{aligned} C_0(p_1^2, p_2^2, p_3^2; m_1^2, m_2^2, m_3^2) &= C_0(p_2^2, p_3^2, p_1^2; m_2^2, m_3^2, m_1^2), & \text{by } (x_1 \rightarrow x_3 \rightarrow x_2 \rightarrow x_1) \\ C_0(p_1^2, p_2^2, p_3^2; m_1^2, m_2^2, m_3^2) &= C_0(p_3^2, p_2^2, p_1^2; m_1^2, m_3^2, m_2^2), & \text{by } (x_2 \leftrightarrow x_3) \\ &= C_0(p_2^2, p_1^2, p_3^2; m_3^2, m_2^2, m_1^2), & \text{by } (x_1 \leftrightarrow x_3) \\ &= C_0(p_1^2, p_3^2, p_2^2; m_2^2, m_1^2, m_3^2), & \text{by } (x_1 \leftrightarrow x_2) \end{aligned}$$

B.3.2 Special cases

1. $C_0(m^2, 0, m^2; \lambda^2, m^2, m^2)$ where λ is a small photon mass

\mathcal{D} is expressed as

$$\begin{aligned} \mathcal{D} &= \lambda^2 x_1 + m^2 x_2 + m^2 x_3 - m^2 x_1 x_2 - m^2 x_3 x_1 \\ &= \lambda^2 x_1 + m^2 (x_2 + x_3)(1 - x_1) \end{aligned}$$

We obtain

$$\begin{aligned}
C_0(m^2, 0, m^2; \lambda^2, m^2, m^2) &= - \int dx_1 dx_2 dx_3 \delta(x_1 + x_2 + x_3 - 1) \times \frac{1}{\mathcal{D}} \\
&= - \int_0^1 dx_1 \int_0^{1-x_1} dx_2 \frac{1}{\lambda^2 x_1 + m^2 (1-x_1)^2} = - \frac{1}{m^2} \int_0^1 dx_1 \frac{1-x_1}{\frac{\lambda^2}{m^2} x_1 + (1-x_1)^2} \\
&= - \frac{1}{m^2} \int_0^1 dx \frac{x}{x^2 + \frac{\lambda^2}{m^2} (1-x)} \implies - \frac{1}{m^2} \left(-\frac{1}{2} \log \frac{\lambda^2}{m^2} \right) \quad (342)
\end{aligned}$$

C Formulae for $SU(3)$

- (1) T^a , a 3×3 matrix, is the generator in the fundamental representation of $SU(3)$:
($a = 1, 2, \dots, 8$).

– The basic formulae

$$[T^a, T^b] = if^{abc}T^c, \quad (343)$$

$$\text{tr}(T^a T^b) = T_R \delta^{ab}, \quad \text{with} \quad T_R = \frac{1}{2}, \quad (344)$$

$$T^a T^a = C_F \mathbf{1}, \quad \text{with} \quad C_F = \frac{4}{3}, \quad (345)$$

$$f^{acd} f^{bcd} = C_G \delta^{ab}, \quad \text{with} \quad C_G = 3, \quad (346)$$

$$(T^a)_{ij} (T^a)_{kl} = \frac{1}{2} (\delta_{il} \delta_{jk} - \frac{1}{3} \delta_{ij} \delta_{kl}) \quad (347)$$

$$f^{abe} f^{cde} + f^{cbe} f^{dae} + f^{dbe} f^{ace} = 0 \quad \Leftarrow \quad \text{Jacobi identity} \quad (348)$$

♠ [Introduction of new notation]

$$\hat{f}^a \hat{f}^b \hat{f}^c \equiv f^{ade} f^{beg} f^{cgd}, \quad \hat{f}^a \hat{f}^b \hat{f}^c \hat{f}^d \equiv f^{ade} f^{beg} f^{cgh} f^{dhd} \quad (349)$$

so that $\hat{f}^a \hat{f}^b \hat{f}^c = \hat{f}^c \hat{f}^a \hat{f}^b = \dots$ and $\hat{f}^a \hat{f}^b \hat{f}^c \hat{f}^d = \hat{f}^d \hat{f}^a \hat{f}^b \hat{f}^c = \dots$

– Other formulae

$$f^{abc} T^b T^c = \frac{1}{2} f^{abc} [T^b, T^c] = \frac{1}{2} f^{abc} i f^{bcd} T^d = \frac{i}{2} C_G T^a \quad (350)$$

$$\begin{aligned}
T^b T^a T^b &= [T^b, T^a] T^b + T^a T^b T^b = i f^{bac} T^c T^b + T^a C_F \mathbf{1} \\
&= (C_F - \frac{C_G}{2}) T^a \quad (351)
\end{aligned}$$

$$(i) \quad f^{ade} f^{beg} f^{cgd} = \hat{f}^a \hat{f}^b \hat{f}^c$$

$$\text{tr}\left(\left[[T^e, T^a], [T^b, T^e]\right]T^c\right) = i f^{ead} i f^{beg} \frac{1}{2} i f^{dgc} = \frac{i}{2} f^{ade} f^{beg} f^{cgd} \quad (352)$$

Using (345) and (351),

$$\begin{aligned} l.h.s. &= \text{tr}\left((T^e T^a - T^a T^e)(T^b T^e - T^e T^b)T^c\right. \\ &\quad \left. - (T^b T^e - T^e T^b)(T^e T^a - T^a T^e)T^c\right) \\ &= \text{tr}\left(\frac{C_G}{2} T^a T^b T^c - \frac{C_G}{2} T^b T^a T^c\right) = \frac{C_G}{2} \frac{i}{2} f^{abc} \end{aligned}$$

Thus we obtain

$$f^{ade} f^{beg} f^{cgd} = \hat{f}^a \hat{f}^b \hat{f}^c = \frac{C_G}{2} f^{abc} \quad (353)$$

$$(ii) \quad \hat{f}^a \hat{f}^b \hat{f}^c \hat{f}^d$$

$$\begin{aligned} \text{tr}\left(\left[[T^a, T^e], T^b\right]\left[[T^d, T^e], T^c\right]\right) &= i f^{aeg} i f^{gbm} i f^{den} i f^{nch} \text{tr}(T^m T^h) \\ &= \frac{1}{2} f^{aeg} f^{gbh} f^{den} f^{nch} = \frac{1}{2} f^{aeg} f^{bgh} f^{chn} f^{dne} = \hat{f}^a \hat{f}^b \hat{f}^c \hat{f}^d \quad (354) \end{aligned}$$

On the other hand, the l.h.s. is calculated as

$$\frac{1}{2} C_G \text{tr}(T^a T^b T^c T^d) + \frac{1}{2} C_G \text{tr}(T^d T^c T^b T^a) + \frac{1}{4} \delta^{ad} \delta^{bc} + \frac{1}{4} \delta^{ac} \delta^{bd} + \frac{1}{4} \delta^{ab} \delta^{cd} \quad (355)$$

(2) A^a , a 8×8 matrix, is the generator in the adjoint representation of $SU(3)$.

– The basic formulae

$$[A^a, A^b] = i f^{abc} A^c, \quad (356)$$

$$(A^a)_{bc} = -i f^{abc}, \quad (357)$$

$$\text{tr}(A^a A^b) = (-i)^2 f^{acd} f^{bcd} = f^{acd} f^{bcd} = C_G \delta^{ab}, \quad (358)$$

$$\text{tr}(A^a A^b A^c) = (-i)^3 f^{ade} f^{beh} f^{chd} = i \hat{f}^a \hat{f}^b \hat{f}^c = i \frac{C_G}{2} f^{abc} \quad (359)$$

– Other formulae

$$(\hat{f}^a \hat{f}^b - \hat{f}^b \hat{f}^a) \hat{f}^c \hat{f}^d = -\frac{C_G}{2} f^{abe} f^{cde} \quad (360)$$

$$\hat{f}^a \hat{f}^b (\hat{f}^c \hat{f}^d + \hat{f}^d \hat{f}^c) = \hat{f}^b \hat{f}^a (\hat{f}^c \hat{f}^d + \hat{f}^d \hat{f}^c) \quad (361)$$

$$\hat{f}^a \hat{f}^b \hat{f}^c \hat{f}^d = \hat{f}^b \hat{f}^a \hat{f}^d \hat{f}^c \quad (362)$$

(Proof)

- $(\hat{f}^a \hat{f}^b - \hat{f}^b \hat{f}^a) \hat{f}^c \hat{f}^d = i^4 \text{tr}([A^a, A^b] A^c A^d)$
 $= i f^{abe} \text{tr}(A^e A^c A^d) = i f^{abe} i \frac{C_G}{2} f^{ecd} = -\frac{C_G}{2} f^{abe} f^{cde}$
- $(\hat{f}^a \hat{f}^b - \hat{f}^b \hat{f}^a)(\hat{f}^c \hat{f}^d + \hat{f}^d \hat{f}^c) = -\frac{C_G}{2} f^{abe} (f^{cde} + f^{dce}) = 0$
- $\hat{f}^a \hat{f}^b \hat{f}^c \hat{f}^d - \hat{f}^b \hat{f}^a \hat{f}^d \hat{f}^c = (\hat{f}^a \hat{f}^b - \hat{f}^b \hat{f}^a) \hat{f}^c \hat{f}^d + \hat{f}^b \hat{f}^a (\hat{f}^c \hat{f}^d - \hat{f}^d \hat{f}^c)$
 $= -\frac{C_G}{2} f^{abe} f^{cde} - \frac{C_G}{2} f^{cde} f^{bae} = 0$

(363)

– Using the properties $\hat{f}^a \hat{f}^b \hat{f}^c \hat{f}^d = \hat{f}^d \hat{f}^a \hat{f}^b \hat{f}^c = \dots$ and (362), we find

$$\hat{f}^a \hat{f}^c \hat{f}^d \hat{f}^b = \hat{f}^a \hat{f}^b \hat{f}^d \hat{f}^c \quad (364)$$

$$\hat{f}^a \hat{f}^d \hat{f}^b \hat{f}^c = \hat{f}^a \hat{f}^c \hat{f}^b \hat{f}^d \quad (365)$$

$$\hat{f}^a \hat{f}^d \hat{f}^c \hat{f}^b = \hat{f}^a \hat{f}^b \hat{f}^c \hat{f}^d \quad (366)$$

(3) $W_{\mu\nu\tau\kappa}^{abge} W_{\kappa\tau\rho\sigma}^{egcd}$ (for definition of $W_{\mu\nu\tau\kappa}^{abge}$, see (124))

$$\begin{aligned} W_{\mu\nu\tau\kappa}^{abge} W_{\kappa\tau\rho\sigma}^{egcd} &= -\left(g^{\mu\rho} g^{\nu\sigma} (2f_{agh} f_{beg} (f_{cdj} f_{ejh} - f_{cjh} f_{dej}) - 3C_G f_{abg} f_{cdg})\right. \\ &\quad \left.+ g^{\mu\sigma} g^{\nu\rho} (3C_G f_{abg} f_{cdg} - 2f_{agh} f_{beg} (f_{cej} f_{djh} + f_{cdj} f_{ejh}))\right. \\ &\quad \left.- 2(n-2)g^{\mu\nu} g^{\rho\sigma} f_{agh} f_{beg} (f_{cjh} f_{dej} + f_{cej} f_{djh})\right) \\ &= -g^{\mu\rho} g^{\nu\sigma} \left\{ 2f_{cdj} (\hat{f}^a \hat{f}^j \hat{f}^b) - 2(\hat{f}^a \hat{f}^c \hat{f}^d \hat{f}^b) - 3C_G f_{abg} f_{cdg} \right\} \\ &\quad -g^{\mu\sigma} g^{\nu\rho} \left\{ 3C_G f_{abg} f_{cdg} - 2(\hat{f}^a \hat{f}^d \hat{f}^c \hat{f}^b) - 2f_{cdj} (\hat{f}^a \hat{f}^j \hat{f}^b) \right\} \\ &\quad + 4g^{\mu\nu} g^{\rho\sigma} \left\{ \hat{f}^a \hat{f}^c \hat{f}^d \hat{f}^b + \hat{f}^a \hat{f}^d \hat{f}^c \hat{f}^b \right\} \\ &= g^{\mu\rho} g^{\nu\sigma} \left\{ 2(\hat{f}^a \hat{f}^c \hat{f}^d \hat{f}^b) + 4C_G f_{abg} f_{cdg} \right\} + g^{\mu\sigma} g^{\nu\rho} \left\{ 2(\hat{f}^a \hat{f}^d \hat{f}^c \hat{f}^b) - 4C_G f_{abg} f_{cdg} \right\} \\ &\quad + 4g^{\mu\nu} g^{\rho\sigma} \left\{ \hat{f}^a \hat{f}^b (\hat{f}^c \hat{f}^d + \hat{f}^d \hat{f}^c) \right\} \end{aligned} \quad (367)$$

where we put $n = 4$ and the formulae (353), (362), (364) and (366) are used.

D Renormalization Group Equation (RGE)

D.1 RGE in MS scheme

1PI(One Particle Irreducible) Green function for field ϕ

$$\Gamma_B^{(n)}(p_i, g_0, m_0) = Z_\phi^{-n/2} \Gamma_R^{(n)}(p_i, g_R, m_R, \mu) \quad (368)$$

with $\phi_0 = Z_\phi^{1/2} \phi_R$

L.H.S. does not depend on scale parameter $\mu \implies$ RGE

$$\begin{aligned} 0 &= \mu \frac{d}{d\mu} \Gamma_B^{(n)}(p_i, g_0, m_0) \\ &= \mu \frac{\partial Z_\phi^{-n/2}}{\partial \mu} \Big|_{g_0, m_0} \Gamma_R^{(n)} + Z_\phi^{-n/2} \left(\mu \frac{\partial}{\partial \mu} + \mu \frac{\partial g_R}{\partial \mu} \frac{\partial}{\partial g_R} + \mu \frac{\partial m_R}{\partial \mu} \frac{\partial}{\partial m_R} \right) \Gamma_R^{(n)} \Big|_{g_0, m_0} \end{aligned}$$

Thus we obtain

$$\left(\mu \frac{\partial}{\partial \mu} + \beta(g_R) \frac{\partial}{\partial g_R} - \gamma_m(g_R) m_R \frac{\partial}{\partial m_R} - n \gamma_\phi(g_R) \right) \Gamma_R^{(n)}(p_i, g_R, m_R, \mu) = 0 \quad (369)$$

$$\beta(g_R) = \mu \frac{\partial g_R}{\partial \mu} \Big|_{g_0, m_0} \quad (370)$$

$$\gamma_m(g_R) = - \frac{\mu}{m_R} \frac{\partial m_R}{\partial \mu} \Big|_{g_0, m_0} \quad (371)$$

$$\gamma_\phi(g_R) = \frac{\mu}{2Z_\phi} \frac{\partial Z_\phi}{\partial \mu} \Big|_{g_0, m_0} \quad (372)$$

- $\beta(g_R)$, $\gamma_m(g_R)$ and $\gamma_\phi(g_R)$ do not depend on m_R in MS scheme.

MS scheme: mass-independent renormalization procedure

γ_ϕ : anomalous dimension of ϕ field (deviation of the scale dimension from the canonical one)

D.1.1 Solution of RGE

♣ Renormalization group equation (the suffix R are suppressed)

$$\left(\mu \frac{\partial}{\partial \mu} + \beta(g) \frac{\partial}{\partial g} - \gamma_m(g) m \frac{\partial}{\partial m} - n \gamma_\phi(g) \right) \Gamma^{(n)}(\lambda p_i, g, m, \mu) = 0 \quad (373)$$

♣ Solution

$$\begin{aligned} \Gamma^{(n)}(\lambda p_i, g, m, \mu) &= \Gamma^{(n)}(p_i, \bar{g}(t), \bar{m}(t), \mu) \\ &\times \exp \left[(4-n)t - n \int_0^t dt' (\gamma_\phi(\bar{g}(t'))) \right] \end{aligned} \quad (374)$$

with the running coupling constant $\bar{g}(t)$ and the running mass $\bar{m}(t)$:

$$\frac{d\bar{g}}{dt} = \beta(\bar{g}), \quad \frac{d\bar{m}}{dt} = \bar{m} \{-1 - \gamma_m(\bar{g})\} \quad (375)$$

$$\bar{g}(0) = g, \quad \bar{m}(0) = m \quad (376)$$

Integrated forms:

$$t = \int_g^{\bar{g}(t)} \frac{dg'}{\beta(g')} \quad (377)$$

$$\bar{m}(t) = m \exp \left[-t - \int_0^t dt' (\gamma_m(\bar{g}(t'))) \right] \quad (378)$$

- By naive dimension counting, $\Gamma^{(n)}(\lambda p_i, g, m, \mu)$ is written in the form

$$\Gamma^{(n)}(\lambda p_i, g, m, \mu) = \mu^{4-n} \Phi^{(n)} \left(\frac{\lambda p_i}{\mu}, g, \frac{m}{\mu} \right) \quad (379)$$

Since $\mu \frac{\partial \Phi^{(n)}}{\partial \mu} = -\lambda \frac{\partial \Phi^{(n)}}{\partial \lambda} - m \frac{\partial \Phi^{(n)}}{\partial m}$,

$$\mu \frac{\partial \Gamma^{(n)}}{\partial \mu} = (4-n)\Gamma^{(n)} - \lambda \frac{\partial \Gamma^{(n)}}{\partial \lambda} - m \frac{\partial \Gamma^{(n)}}{\partial m} \quad (380)$$

♡ Setting $t = \ln \lambda$, and thus $\lambda \frac{\partial}{\partial \lambda} = \frac{\partial}{\partial t}$, the RGE eq.(373) is rewritten as

$$\left(-\frac{\partial}{\partial t} + \beta(g) \frac{\partial}{\partial g} - [1 + \gamma_m(g)] m \frac{\partial}{\partial m} + [4 - n - n\gamma_\phi(g)] \right) \Gamma^{(n)}(\lambda p_i, g, m, \mu) = 0 \quad (381)$$

[Proof]

- $\bar{g}(t)$ depends also on the boundary condition $g \rightarrow \bar{g}(t, g)$

- Differentiate both sides of (377) by $g \Rightarrow 0 = \frac{\partial \bar{g}}{\partial g} \frac{1}{\beta(\bar{g})} - \frac{1}{\beta(g)}$

$$\frac{\partial \bar{g}}{\partial g} = \frac{\beta(\bar{g})}{\beta(g)} \quad (382)$$

- Since $\int_0^t dt' (\gamma_m(\bar{g}(t'))) = \int_{\bar{g}}^g \frac{dg'}{\beta(g')} \gamma_m(g')$, we have

$$\begin{aligned} \frac{\partial \bar{m}}{\partial g} &= \bar{m} \left\{ -\frac{\partial}{\partial g} \int_0^t dt' (\gamma_m(\bar{g}(t'))) \right\} = \bar{m} \left\{ -\frac{\partial \bar{g}}{\partial g} \frac{\gamma_m(\bar{g})}{\beta(\bar{g})} + \frac{\gamma_m(g)}{\beta(g)} \right\} \\ &= \bar{m} \frac{1}{\beta(g)} \{-\gamma_m(\bar{g}) + \gamma_m(g)\} \end{aligned} \quad (383)$$

- Similarly

$$\frac{\partial}{\partial g} \exp \left[-n \int_0^t dt' (\gamma_\phi(\bar{g}(t'))) \right] = \exp \left[-n \int_0^t dt' (\gamma_\phi(\bar{g}(t'))) \right] \frac{n}{\beta(g)} \{-\gamma_\phi(\bar{g}) + \gamma_\phi(g)\} \quad (384)$$

Thus

$$\begin{aligned} &\left(-\frac{\partial}{\partial t} + \beta(g) \frac{\partial}{\partial g} \right) \exp \left[(4-n)t - n \int_0^t dt' (\gamma_\phi(\bar{g}(t'))) \right] \\ &= \exp[\dots] \left\{ -4 + n + n\gamma_\phi(\bar{g}) + n(-\gamma_\phi(\bar{g}) + \gamma_\phi(g)) \right\} \\ &= \exp[\dots] \left\{ -4 + n + n\gamma_\phi(g) \right\} \end{aligned} \quad (385)$$

- Inserting the r.h.s. of the solution (374) into (381), we have

$$\begin{aligned} l.h.s. &= \left\{ \left(-\frac{\partial}{\partial t} + \beta(g) \frac{\partial}{\partial g} - [1 + \gamma_m(g)] m \frac{\partial}{\partial m} \right) \Gamma^{(n)}(p_i, \bar{g}, \bar{m}, \mu) \right\} \exp[\dots] \\ &\quad + \Gamma^{(n)}(p_i, \bar{g}, \bar{m}, \mu) \left\{ \left(-\frac{\partial}{\partial t} + \beta(g) \frac{\partial}{\partial g} \right) \exp[\dots] \right\} \\ &\quad + (4-n-n\gamma_\phi(g)) \Gamma^{(n)}(p_i, \bar{g}, \bar{m}, \mu) \exp[\dots] \end{aligned} \quad (386)$$

\implies The 2nd and 3rd terms cancel out.

- The first term

$$\begin{aligned} &\left(-\frac{\partial}{\partial t} + \beta(g) \frac{\partial}{\partial g} - [1 + \gamma_m(g)] m \frac{\partial}{\partial m} \right) \Gamma^{(n)}(p_i, \bar{g}, \bar{m}, \mu) \\ &= \left\{ -\frac{\partial \bar{g}}{\partial t} + \beta(g) \frac{\partial \bar{g}}{\partial g} \right\} \frac{\partial \Gamma^{(n)}}{\partial \bar{g}} \\ &\quad + \left\{ -\frac{\partial \bar{m}}{\partial t} + \beta(g) \frac{\partial \bar{m}}{\partial g} - [1 + \gamma_m(g)] m \frac{\partial \bar{m}}{\partial m} \right\} \frac{\partial \Gamma^{(n)}}{\partial \bar{m}} \\ &= 0 \times \frac{\partial \Gamma^{(n)}}{\partial \bar{g}} \\ &\quad + \left\{ \bar{m} [1 + \gamma_m(\bar{g})] + \bar{m} [-\gamma_m(\bar{g}) + \gamma_m(g)] - [1 + \gamma_m(g)] \bar{m} \right\} \frac{\partial \Gamma^{(n)}}{\partial \bar{m}} \\ &= 0 \end{aligned} \quad (387)$$

E DIS from a Coordinate Space Viewpoint

(Ref.)

R. L. Jaffe: SPIN, TWIST and HADRON STRUCTURE IN DIS, hep-ph/9602236

E.1 Short-Distance Expansion

E.1.1 $e^+e^- \rightarrow$ hadrons

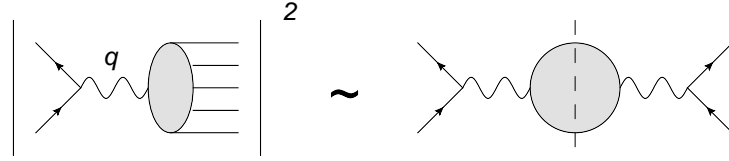

Figure 34: $e^+e^- \rightarrow$ hadrons

$$\sigma_{\text{tot}} = \frac{16\pi^2\alpha^2}{Q^2}\Pi(Q^2) \quad (= \frac{4\pi\alpha^2}{3Q^2}R) \quad (388)$$

where $q = k + k'$, $(Q^2 \equiv q^2 > 0)$,

$$\Pi_{\mu\nu} = (q_\mu q_\nu - q^2 g_{\mu\nu})\Pi(Q^2)$$

$$\Pi(Q^2) = -\frac{1}{6Q^2} \int d^4\xi e^{iq\xi} \langle 0 | [J_\mu(\xi), J^\mu(0)] | 0 \rangle \quad (389)$$

- The commutator is causal

$$[J_\mu(\xi), J_\nu(0)] = 0, \quad \text{for } \xi^2 < 0 \quad (390)$$

then $|\vec{\xi}| < \xi^0$ in the integral.

- In the CM system, $q = (\sqrt{Q^2}, \vec{0})$,

$$\Pi(Q^2) \propto \int_0^\infty d\xi^0 \sin(q^0 \xi^0) \int_{|\vec{\xi}| \leq \xi^0} d^3\xi \langle 0 | [J_\mu(\xi), J^\mu(0)] | 0 \rangle \quad (391)$$

due to the fact

$$\langle 0 | [J_\mu(-\xi), J^\mu(0)] | 0 \rangle = \langle 0 | [J_\mu(0), J^\mu(\xi)] | 0 \rangle = -\langle 0 | [J^\mu(\xi), J_\mu(0)] | 0 \rangle \quad (392)$$

- In the high energy limit, $Q \rightarrow \infty$,

$\implies \sin(q^0 \xi^0)$ oscillates rapidly
 \implies the region $\xi^0 \sim \frac{1}{q^0} = \frac{1}{Q}$ gives the dominant contribution
 \implies since $\xi^0 > |\vec{\xi}|$, σ_{tot} at high Q^2 is dominated by interactions
 at short distances, $\xi^\mu \rightarrow 0$.

E.1.2 The OPE at short distances

OPE: a product of local operators $\hat{A}(\xi)$ and $\hat{B}(0)$ at short distances can be expanded in a series of *non-singular* local operators \times c-number *singular* functions,

$$\hat{A}(\xi)\hat{B}(0) \sim \sum_i C_i(\xi)\hat{\theta}_i(0) \quad \text{as } \xi^\mu \rightarrow 0 \quad (393)$$

- In general the product $\hat{A}(\xi)\hat{B}(0)$ is singular as $\xi^\mu \rightarrow 0$.
But the singularities can be isolated in the c-number "Wilson coefficients", C_i .
- The behavior of the Wilson coefficients as $\xi^\mu \rightarrow 0$ follows from dimensional analysis.

[Canonical dimension]

$$[\text{mass}] = 1, \quad [\psi] = \frac{3}{2}, \quad [J^\mu] = 3, \quad [F_{\mu\nu}] = [G_{\mu\nu}] = 2, \quad [P^\mu] = [S^\mu] = 1 \quad (394)$$

$$\text{covariant state normalization} \Rightarrow [\langle P|P' \rangle] = -2, \quad [W_{\mu\nu}] = 0 \quad (395)$$

OPE requires

$$[\hat{A}] + [\hat{B}] = [C_i] + [\hat{\theta}_i] \quad (396)$$

The renormalization scale, μ , necessary to render the theory finite can only appear in logarithms of the form $\ln(\mu\xi)$

◇ The behavior of the Wilson coefficients

$$C_i(\xi) \sim \frac{1}{\xi^{[\hat{A}]+[\hat{B}]-[\hat{\theta}_i]}} (\ln^{\gamma_\theta}(\mu\xi) + \dots) \quad (397)$$

- The exponent γ_θ : the "anomalous dimension" of the operator θ generated by radiative corrections.
- The dominant contribution comes from the term having the lowest operator dimension $[\hat{\theta}_i]$

$[e^+e^- \rightarrow \text{hadrons}]$

The lowest dimension operator is the unit operator $\hat{\theta}_0 \equiv \mathbf{1}$ with $[\mathbf{1}] = 0$

$$\begin{aligned} \langle 0|[J_\mu(\xi), J^\mu(0)]|0\rangle &\sim C_0(\xi) \sim \frac{1}{\xi^6} \\ \Pi(Q^2) &\sim \frac{1}{Q^2} \int d^4\xi e^{iq\cdot\xi} \frac{1}{\xi^6} \sim 1 \\ \sigma(e^+e^- \rightarrow \text{hadrons}) &\sim \frac{1}{Q^2} \end{aligned} \quad (398)$$

E.2 Light-Cone Expansion

E.2.1 DIS and Light-Cone Dominance

We can choose a frame such that P^μ and q^μ have components only in the time and \hat{e}_3 directions

◇ Introduction of two light-like vectors

$$\begin{aligned} p^\mu &= \frac{\mathcal{P}}{\sqrt{2}}(1, 0, 0, 1) , \\ n^\mu &= \frac{1}{\sqrt{2}\mathcal{P}}(1, 0, 0, -1) \end{aligned} \quad (399)$$

with $p^2 = n^2 = 0, \quad p \cdot n = 1$

- Expand P^μ and q^μ in terms of two light-like vectors

$$P^\mu = p^\mu + \frac{M^2}{2}n^\mu \quad (400)$$

$$q^\mu = \frac{1}{M^2} \left(w - \sqrt{w^2 + M^2 Q^2} \right) p^\mu + \frac{1}{2} \left(w + \sqrt{w^2 + M^2 Q^2} \right) n^\mu \quad (401)$$

\mathcal{P} selects a specific frame:

$$\begin{aligned} \mathcal{P} = \frac{M}{\sqrt{2}} &\Rightarrow \text{target rest frame,} \\ \mathcal{P} \rightarrow \infty &\Rightarrow \text{infinite momentum frame} \end{aligned}$$

-
- In the Bjorken limit

$$\lim_{Bj} q^\mu \sim -xp^\mu + \left(w + \frac{1}{2}M^2x \right) n^\mu + \mathcal{O}\left(\frac{1}{Q^2}\right) \quad (402)$$

◇ The space-time region which dominates the DIS

$$W^{\mu\nu} = \frac{1}{4\pi} \int d^4\xi e^{iq\cdot\xi} \langle PS | [J^\mu(\xi), J^\nu(0)] | PS \rangle \quad (403)$$

Difine

$$\xi^\mu \equiv \eta p^\mu + \lambda n^\mu + \xi_\perp^\mu, \quad \text{so} \quad \xi^2 = 2\lambda\eta - \xi_\perp^2 \quad (404)$$

then, in the Bjorken limit

$$\lim_{Bj} q \cdot \xi \sim \eta w - x\lambda \quad (405)$$

\implies the region $\eta \sim 1/w \sim 0$ and $\lambda \sim 1/x$ gives the dominant contribution

\implies since $\xi_\perp^2 < 2\lambda\eta \sim 2/(xw)$ (due to causality), the visinity of the light-cone, $\xi^2 = 0$, dominates the integral

“The Bjorken limit of DIS probes a current correlation function near the light-cone, $\xi^2 = 0$.”

E.2.2 DIS and Short Distance Expansion and Moment Sum Rules

- * QCD simplifies at short distances due to asymptotic freedom.
- * DIS is not a short distance process; it is light-cone dominated.
- * Nevertheless, DIS can be related to the OPE and to short distances.

◇ Bjorken-Johnson-Low limit (\lim_{BJL})

$$\vec{q} = 0 \quad \text{and} \quad q^0 \rightarrow i\infty \quad \implies \quad q^2 \rightarrow -\infty \quad \text{and} \quad x \rightarrow -i\infty \quad (406)$$

- The physical region of x : $0 \leq x \leq 1$
Thus the hadronic tensor $W_{\mu\nu}$ cannot be measured in the BJL limit
- BJL limit is useful because
 - 1) it *is* dominated by short distance \implies we can use OPE
 - 2) it can be related to $W_{\mu\nu}$ in the physical region through dispersion relations \implies we obtain “momentum sum rules”

◇ The forward virtual Compton amplitude, $T_{\mu\nu}$,

$$T_{\mu\nu} = i \int d^4\xi e^{iq\cdot\xi} \langle PS | T(J_\mu(\xi) J_\nu(0)) | PS \rangle \quad (407)$$

- Crossing symmetry: $T_{\mu\nu}(P, -q) = T_{\nu\mu}(P, q)$

- $W_{\mu\nu}$ is the imaginary part of $T_{\mu\nu}$ (the optical theorem): $\text{Im}T_{\mu\nu} = 2\pi W_{\mu\nu}$
Corresponding to F_1 and F_2 in Eq.(285), we have T_1 and T_2 .

◇ Taking the BJL limit ($\vec{q} = 0$ and $q^0 \rightarrow i\infty$) of $T_{\mu\nu}$:

$$\text{The factor } e^{iq\xi} \rightarrow e^{-|q^0|\xi^0} \Rightarrow \xi^0 \rightarrow 0 \Rightarrow \xi^\mu \rightarrow 0,$$

The BJL limit leads us to short distances and the use of OPE is justified.

- $T_i(q^2, x)$ ($i = 1, 2$) in the BJL limit are analytic in $|\frac{1}{x}|$,
and they may be expanded in a Taylor series in powers of $\frac{1}{x}$:
For an example,

$$\lim_{BJL} T_1(q^2, x) = 4 \sum_{n \text{ even}} M_n(q^2) \frac{1}{x^n} \quad (408)$$

where n is even since $T_1(q^2, -x) = T_1(q^2, x)$ from the crossing symmetry.

- Through the OPE of the product of currents, $M_n(q^2)$ s are related to the Fourier transform of the Wilson's coefficient functions multiplied by the matrix elements of the local operators.

◇ Dispersion relation

- Consider $T_{\mu\nu}$ in the complex $\omega = \frac{1}{x}$ plane.

$T_{\mu\nu}(q^2, \omega)$ is an analytic function of ω at fixed spacelike q^2 .

The physical cuts lie on the real axis from $\omega = \pm 1$ to $\pm\infty$

$$\Rightarrow T_{\mu\nu}(q^2, \omega) \text{ is analytic within the unit circle about the origin}$$

The BJL limit correspond to $\omega \rightarrow 0$ along the imaginary axis.

- In the BJL limit, $T_{\mu\nu}(q^2, \omega)$ can be expanded in a Taylor series in ω about the origin.

The coefficients in the Taylor expansion can be obtained from the dispersion relation

$$\begin{aligned} T_1(q^2, \omega) &= \frac{1}{2\pi i} \oint d\omega' \frac{T_1(q^2, \omega')}{\omega' - \omega} \\ &= \frac{1}{2\pi i} \left\{ \int_{-\infty+i\epsilon}^{-1+i\epsilon} + \int_{-1-i\epsilon}^{-\infty-i\epsilon} + \int_{\infty-i\epsilon}^{1-i\epsilon} + \int_{1+i\epsilon}^{\infty+i\epsilon} \right\} d\omega' \\ &= \frac{1}{2\pi i} \left\{ \int_{-\infty}^{-1} d\omega' \frac{T_1(q^2, \omega' + i\epsilon) - T_1(q^2, \omega' - i\epsilon)}{\omega' - \omega} \right. \\ &\quad \left. + \int_1^{\infty} d\omega' \frac{T_1(q^2, \omega' + i\epsilon) - T_1(q^2, \omega' - i\epsilon)}{\omega' - \omega} \right\} \\ &= \frac{1}{2\pi i} \int_1^{\infty} d\omega' \left(\frac{1}{\omega' + \omega} + \frac{1}{\omega' - \omega} \right) \end{aligned}$$

$$\begin{aligned}
& \times \{T_1(q^2, \omega' + i\epsilon) - T_1(q^2, \omega' - i\epsilon)\} \\
& = \frac{1}{\pi} \int_1^\infty d\omega' 2\omega' \frac{\text{Im}T_1(q^2, \omega')}{\omega'^2 - \omega^2} = 4 \int_1^\infty d\omega' \omega' \frac{F_1(q^2, \omega')}{\omega'^2 - \omega^2} \\
& = 4 \sum_{l=0} \omega^{2l} \int_1^\infty d\omega' \frac{1}{\omega'} \left(\frac{1}{\omega'^2}\right)^l F_1(q^2, \omega') \\
& = 4 \sum_{n=\text{even}} \left(\frac{1}{x}\right)^n \int_0^1 dx' x'^{n-1} F_1(q^2, x')
\end{aligned}$$

where

$$\begin{aligned}
T_1(q^2, -\omega' - i\epsilon) &= T_1(q^2, \omega' + i\epsilon) && \text{crossing symmetry} \\
\text{Im}T_1(q^2, \omega) &= 2\pi F_1(q^2, \omega)
\end{aligned}$$

have been used.

- Comparing with Eq.(408), we find

$$M_n(q^2) = \int_0^1 dx x^{n-1} F_1(q^2, x) \quad (409)$$

- * $M_n(q^2)$ (apart from the matrix elements of local operators) can be predicted by pQCD.
- * The information on $F_1(q^2, x)$ is given by experiments.

E.2.3 Light-Cone Expansion

[[Example]] Product of scalar currents

$$\text{scalar current} \quad J(x) = :\phi^2(x): \quad (410)$$

- The normal ordering \Rightarrow remove the singularities which occur in the product $\phi(x + \zeta)\phi(x - \zeta)$ as $\zeta^\mu \rightarrow 0$
- Using the Wick's theorem

$$\begin{aligned}
T(J(x)J(0)) &= T(:\phi^2(x)::\phi^2(0):) \\
&= 2 \{ \langle 0|T(\phi(x)\phi(0))|0\rangle \}^2 + 4 \langle 0|T(\phi(x)\phi(0))|0\rangle : \phi(x)\phi(0): \\
&\quad + : \phi^2(x)\phi^2(0): \\
&= -2 \{ \Delta_F(x) \}^2 + 4i \Delta_F(x) : \phi(x)\phi(0): + : \phi^2(x)\phi^2(0):
\end{aligned}$$

Since the massless propagator is given by $\Delta_F(x) = \frac{i}{4\pi} \frac{1}{x^2 - i\epsilon}$, for $x^2 \approx 0$

$$T(J(x)J(0)) \approx \frac{1}{8\pi^4(x^2 - i\epsilon)^2} - \frac{: \phi(x)\phi(0):}{\pi^2(x^2 - i\epsilon)} + : \phi^2(x)\phi^2(0): \quad (411)$$

★ The first term is irrelevant.

★ The second term \dots a singular function \times a bilocal operator $: \phi(x)\phi(0):$

◇ Light-cone expansion

- Near the light-cone $\xi^2 \approx 0$, the product of two local operators is expanded:

$$\hat{A}(\xi)\hat{B}(0) \sim \sum_i C_i(\xi^2)\hat{O}_i(\xi, 0) \quad \text{for } \xi^2 \approx 0 \quad (412)$$

$C_i(\xi^2) \dots$ singular c -number functions

$\hat{O}_i(\xi, 0) \dots$ regular bilocal operators

- Expand the bilocal operators in a Taylor series

$$\hat{O}_i(x, 0) = \sum_{n_\theta} \xi^{\mu_1} \dots \xi^{\mu_{n_\theta}} \hat{\theta}_{\mu_1 \dots \mu_{n_\theta}}(0) \quad (413)$$

↓

$$\hat{A}(\xi)\hat{B}(0) \sim \sum_{[\theta]} C_{[\theta]}(\xi^2) \xi^{\mu_1} \dots \xi^{\mu_{n_\theta}} \hat{\theta}_{\mu_1 \dots \mu_{n_\theta}}(0) \quad (414)$$

E.2.4 OPE and Twist

Recall the forward virtual Compton amplitude, $T_{\mu\nu}$, in Eq.(407)

$$T_{\mu\nu} = i \int d^4\xi e^{iq \cdot \xi} \langle PS | T(J_\mu(\xi)J_\nu(0)) | PS \rangle \quad (415)$$

Near the light-cone, $\xi^2 \approx 0$,

$$T(J_\mu(\xi)J_\nu(0)) \sim \sum_{[\theta]} K_{[\theta]}(\xi^2) \xi^{\mu_1} \dots \xi^{\mu_{n_\theta}} \hat{\theta}_{\mu_1 \dots \mu_{n_\theta}}(0) \quad (416)$$

- The degree of the light-cone singularity of $K_{[\theta]}(\xi^2)$

$$K_{[\theta]}(\xi^2) \sim \xi^{-6+d_\theta-n_\theta} \quad (417)$$

Define the twist of the operator $\hat{\theta}_{\mu_1 \dots \mu_{n_\theta}}$

$$t_\theta \equiv d_\theta - n_\theta \quad (418)$$

⇒ Operators of the same singularities at $\xi^2 = 0$ (which means the same twist) are of the same importance

⇒ Operators with the lowest twist give the dominant contributions

- Consider, for example, $T_1(q^2, x)$,

$$T_1(q^2, x) = i \int d^4\xi e^{iq\cdot\xi} \sum_{[\theta]} K_{[\theta]}(\xi^2) \xi^{\mu_1} \dots \xi^{\mu_{n_\theta}} \langle P | \hat{\theta}_{\mu_1 \dots \mu_{n_\theta}}(0) | P \rangle \quad (419)$$

The matrix elements have the form:

$$\langle P | \hat{\theta}_{\mu_1 \dots \mu_{n_\theta}}(0) | P \rangle = P_{\mu_1} \dots P_{\mu_{n_\theta}} \mathcal{M}^{t_\theta-2} a_\theta + \dots \quad (420)$$

Carry out the Fourier transformation

$$\begin{aligned} \text{(substitution)} \quad \xi^\mu &\longrightarrow -2iq^\mu \frac{\partial}{\partial q^2} \\ e^{iq\cdot\xi} \xi^{\mu_1} \dots \xi^{\mu_{n_\theta}} \langle P | \hat{\theta}_{\mu_1 \dots \mu_{n_\theta}}(0) | P \rangle &\sim \left[\frac{-2iP \cdot q}{q^2} \right]^{n_\theta} \left(q^2 \frac{\partial}{\partial q^2} \right)^{n_\theta} M^{t_\theta-2} a_\theta \\ \left(\frac{\partial}{\partial q^2} \right)^{n_\theta} \int d^4\xi e^{iq\cdot\xi} K_{[\theta]}(\xi^2) &\sim \left(\sqrt{-q^2} \right)^{2-t_\theta} \end{aligned}$$

Thus we have

$$T_1(q^2, x) \sim \sum_{[\theta]} \left(\frac{\mathcal{M}}{\sqrt{-q^2}} \right)^{t_\theta-2} \left(\frac{1}{x} \right)^{n_\theta} a_\theta \quad (421)$$

Setting $n_\theta = n$, we find $M_n(q^2)$ in Eq.(408) is related the Fourier transform of $K_{[\theta]}(\xi^2)$:

$$M_n(q^2) \sim \left(\frac{\mathcal{M}}{\sqrt{-q^2}} \right)^{t_\theta-2} a_\theta \quad (422)$$

- The lowest twist operators in QCD have $t_\theta = 2$
 $\Rightarrow M_n(q^2)$ scales – modulo logarithms– in the Bjorken limit

F QCD Analysis of Structure Functions – OPE and RGE method –

- Light-cone dominance

We are interested in Bjorken limit:

$$Q^2, \quad p \cdot q \rightarrow \infty \quad \text{with} \quad x = \frac{Q^2}{2p \cdot q} \quad \text{fixed}$$

Main contributions come from

$$0 \leq \xi^2 \leq \frac{1}{Q^2}$$

- Light-cone expansion of current product

When $\xi^2 \rightarrow 0$ but $\xi^\mu \neq 0$

$$J(\xi)J(0) \sim \sum_{i,n} C_{i,n}(\xi^2) \xi^{\mu_1} \xi^{\mu_2} \dots \xi^{\mu_n} O_{\mu_1 \mu_2 \dots \mu_n}^{i,n}(0)$$

So

$$C_{i,n}(\xi^2) \sim (\xi^2)^{(d_o^n - n - 2d_J)/2}$$

The operators with the lowest twist dominate

$$\text{twist} : t_o^n \equiv d_o^n - n$$

Choose composite operators $O^{i,n}$ with lowest twist and irreducible rep. of spin n

$$\begin{aligned} O_{\mu_1 \mu_2 \dots \mu_n}^{i,n} & : \quad \text{traceless} \quad (g^{\mu_1 \mu_2} O_{\mu_1 \mu_2 \dots \mu_n}^{i,n} = 0, \quad \text{etc}) \\ & : \quad \text{symmetric in Lorentz indices} \end{aligned}$$

- Renormalization group eq. for Coefficient functions

– Green function of currents and fundamental field ϕ

$$\begin{aligned} & \langle 0 | T [J(\xi)J(0)\phi(\xi_1)\phi(\xi_2) \dots \phi(\xi_n)] | 0 \rangle \\ & = \sum_{i,n} C_{i,n}(\xi^2) \xi^{\mu_1} \dots \xi^{\mu_n} \langle 0 | T [O^{i,n}(0) \phi(\xi_1)\phi(\xi_2) \dots \phi(\xi_n)] | 0 \rangle \end{aligned}$$

– in momentum space

$$G_{JJ}^n(q, p_1, \dots, p_n) = \sum_{i,n} \tilde{C}_{i,n}(q^2) \frac{q^{\mu_1} \dots q^{\mu_n}}{(q^2)^n} G_{\mu_1 \dots \mu_n}^{i,n}(p_1, \dots, p_n) \quad (423)$$

where

$$\begin{aligned} G_{JJ}^n(q, p_1, \dots, p_n) & = \int d^4 \xi d^4 \xi_1 \dots d^4 \xi_n e^{(iq \cdot \xi + ip_1 \cdot \xi_1 + \dots + ip_n \cdot \xi_n)} \\ & \times \langle 0 | T [J(\xi)J(0)\phi(\xi_1)\phi(\xi_2) \dots \phi(\xi_n)] | 0 \rangle \Delta^{-1}(p_1) \dots \Delta^{-1}(p_n) \end{aligned}$$

$$\tilde{C}_{i,n}(q^2) \frac{q^{\mu_1} \dots q^{\mu_n}}{(q^2)^n} = \int d^4 \xi e^{iq \cdot \xi} \xi^{\mu_1} \dots \xi^{\mu_n} C_{i,n}(\xi^2)$$

$$\begin{aligned} G_{\mu_1 \dots \mu_n}^{i,n}(p_1, \dots, p_n) & = \int d^4 \xi_1 \dots d^4 \xi_n e^{(ip_1 \cdot \xi_1 + \dots + ip_n \cdot \xi_n)} \\ & \times \langle 0 | T [O^{i,n}(0) \phi(\xi_1)\phi(\xi_2) \dots \phi(\xi_n)] | 0 \rangle \Delta^{-1}(p_1) \dots \Delta^{-1}(p_n) \end{aligned}$$

– RGE for G_{JJ}^n

$$[\mathcal{D} + 2\gamma_J - n\gamma_\phi]G_{JJ}^n = 0 \quad (424)$$

where

$$\mathcal{D} = \mu \frac{d}{d\mu} = \mu \frac{\partial}{\partial \mu} + \beta(g) \frac{\partial}{\partial g} - \gamma_m(g)m \frac{\partial}{\partial m}$$

γ_j, γ_ϕ : anomalous dimension of J, ϕ

– RGE for $G_{\mu_1 \dots \mu_n}^{i,n}$

$$[\mathcal{D} + \gamma_n^i - n\gamma_\phi]G_{\mu_1 \dots \mu_n}^{i,n} = 0 \quad (425)$$

γ_n^i : anomalous dimension of operator $O_{\mu_1 \dots \mu_n}^{i,n}$

$$\gamma_n^i = \mu \frac{d}{d\mu} \ln Z_O, \quad O_{\mu_1 \dots \mu_n}^{\text{Bare}} = Z_O O_{\mu_1 \dots \mu_n}^{\text{Renor}}$$

– Thus we obtain RGE for Coefficient functions from (424) and (425)

$$[\mathcal{D} + 2\gamma_J - \gamma_n^i] \tilde{C}_{i,n}(q^2) = 0 \quad (426)$$

• Solution to RGE

– When J_μ is electromagnetic current $\implies \gamma_J = 0$

– Eq.(426) is written as

$$\left(\mu \frac{\partial}{\partial \mu} + \beta(g) \frac{\partial}{\partial g} - \gamma_m(g)m \frac{\partial}{\partial m} - \gamma_n^i(g) \right) \tilde{C}_{i,n}(q^2) = 0 \quad (427)$$

Note that $\tilde{C}_{i,n}(q^2)$ is dimensionless when $O_{\mu_1 \dots \mu_n}^{i,n}$ is twist-2.

– Setting $\tilde{C}_{i,n}(q^2) = \tilde{C}_{i,n}(\frac{Q^2}{\mu^2}, g, m)$ with $Q^2 \equiv -q^2$ and μ the renormalization scale, the solution is written as

$$\tilde{C}_{i,n}(\frac{Q^2}{\mu^2}, g, m) = \tilde{C}_{i,n}(1, \bar{g}(t), \bar{m}(t)) \exp \int_0^t dt' [-\gamma_n^i(g(t'))]$$

where (see Eqs.(375) and (376))

$$\begin{aligned} t &= \frac{1}{2} \ln \frac{Q^2}{\mu^2} \quad \Rightarrow \quad \mu \frac{\partial}{\partial \mu} = -\frac{\partial}{\partial t} \\ \frac{d\bar{g}}{dt} &= \beta(\bar{g}), \quad \frac{d\bar{m}}{dt} = -(1 + \gamma_m(\bar{g}))\bar{m} \\ \bar{g}(0) &= g, \quad \bar{m}(0) = m \end{aligned} \quad (428)$$

$$\left(-\frac{\partial}{\partial t} + \beta(g) \frac{\partial}{\partial g} - [1 + \gamma_m(g)] m \frac{\partial}{\partial m} - \gamma_n^i(g) \right) \tilde{C}_{i,n}(\frac{Q^2}{\mu^2}, g, m) = 0 \quad (429)$$